

The cover features a dark red background with a close-up of a Gibson electric guitar's body on the right side. The guitar has a sunburst finish and two humbucker pickups. On the left, a portion of a guitar's fretboard is visible, showing the grid lines and fret markers. The text is overlaid on the dark red background.

Gibson's[®]

Learn & Master[®]
GUITAR

with Steve Krenz

LESSON BOOK

LEGACY
LEARNING SYSTEMS

Gibson's

Learn & Master®

GUITAR

with Steve Krenz

LESSON BOOK

LEGACY
LEARNING SYSTEMS

www.LearnAndMaster.com

Legacy Learning Systems
2510 Franklin Pike, Suite 200
Nashville, TN 37204

Gibson's® Learn and Master® Guitar.
Copyright © 2010 by Legacy Learning Systems, Inc.
All rights reserved.

No part of this product, including its DVDs, CDs, printed materials, and packaging, may be used or reproduced in any manner whatsoever without written permission, except in the case of brief quotations embodied in critical articles and reviews. For reproduction information, write to Legacy Learning Systems, 624 Grassmere Park Dr., Suite 16, Nashville, TN, 37211.

LEARN & MASTER is a registered trademark of Legacy Learning Systems, Inc.

GIBSON, the Gibson logo, and the Gibson headstock are registered trademarks of Gibson Guitar Corp. and are used under license.

First Edition

ISBN 13: 978-0-9841193-7-0
ISBN 10: 0-9841193-7-x

Printed in China

10 11 12 13 8 7 6 5 4 3 2 1

www.LearnandMaster.com

Table of Contents

SESSIONS	PAGE
1) Starting Off Right	2
<i>String Names, Technique, Tuning, Finger Exercises, C & G7 Chords</i>	
2) Reading Music & Notes on the 1st & 2nd Strings	7
<i>Music Reading, 1st & 2nd String Notes & Exercises</i>	
• Ode To Joy (CD #1 Tracks 2,3,4)	14
• Jingle Bells (CD #1 Tracks 5,6,7)	15
3) Notes on the 3rd & 4th Strings	16
<i>Ties, Dots, Repeat Signs, Eighth Notes, 3rd & 4th String Notes & Exercises</i>	
• Yankee Doodle (CD #1 Tr. 8,9,10)	21
• When The Saints Go Marchin' In (CD #1 Tr. 11,12,13)	21
• Aura Lee (CD #1 Tr. 14,15,16)	22
4) Notes on the 5th & 6th Strings	23
<i>5th & 6th String Notes & Exercises, Sharps, Flats, Natural Signs, Am & E Chords</i>	
• Minuet in C (CD #1 Tr. 17,18,19)	26
• Simple Gifts (CD #1 Tr. 20,21,22)	28
• The Star Spangled Banner (CD #1 Tr. 23,24,25)	29
• Minuet in G (CD #1 Tr. 26,27,28)	30
5) Basic Open Chords	31
<i>Open Chords & Chord Exercises 1-3</i>	
• Morning Has Broken (CD #2 Tr. 2,3,4)	35
• America The Beautiful (CD #2 Tr. 5,6,7)	36
6) Minor Seventh & Suspended Chords	37
<i>Minor Seventh & Suspended Chords & Strumming Patterns</i>	
• Scarborough Fair (CD #2 Tr. 8,9,10)	41
• Greensleeves (CD #2 Tr. 11,12,13)	42
• Island Groove (CD #2 Tr. 14,15,16)	42
7) Barre Chords on the 6th String	43
<i>Half-Steps & Whole Steps, 6th String Barre Chords & Exercises, Major Scales</i>	
• Home on the Range (CD #2 Tr. 17,18,19)	47
• Yellow Rose of Texas (CD #2 Tr. 20,21,22)	47
8) Barre Chords on the 5th String	48
<i>5th String Barre Chords & Exercises, Keys & Key Signatures, Relative Major & Minor</i>	
• Jamaica Farewell in F (CD #2 Tr. 23,24,25)	51
• Jamaica Farewell in G (CD #2 Tr. 26,27,28)	51
9) The Secret to Great Strumming	52
<i>Strumming Technique, Intervals & Worksheets</i>	
• La Bamba (CD #3 Tr. 2,3,4)	55
• The Wabash Cannonball (CD #3 Tr. 5,6,7)	56
• Blues in E (CD #3 Tr. 8,9,10)	56
10) Fingerstyle Guitar	57
<i>Technique & Exercises, Merle Travis & Classical</i>	
• House of the Rising Sun (CD #3 Tr. 11,12,13)	61
• Canon in D (CD #3 Tr. 14,15,16)	62

SESSIONS	PAGE
11) Pentatonic Scales	63
<i>Pentatonic Scales, Forms & Pentatonic Patterns</i>	
• A Minor Pentatonic Blues (CD #3 Tr. 17)	66
• G Major Pentatonic (CD #3 Tr. 18)	66
• Around the Pentatonic World (CD #3 Tr. 19)	66
12) Advanced Chords	67
<i>Two Chords, Major 7th Chords, Minor 11th Chords, Exercises & Chord Substitution</i>	
• Rockin' (CD #3 Tr. 20)	70
• Suspended Smooth (CD #3 Tr. 21)	70
• Acoustic Groove (CD #3 Tr. 22)	70
13) Playing the Blues	71
<i>Blues Scale, Minor Pentatonic with Blues Notes, Blues Chord Progression, Triads & Worksheets</i>	
• Jammin the Blues (CD #4 Tr. 2,3)	75
• Johnny's E Blues (CD #4 Tr. 4,5)	75
14) Giving Your Playing Some Style	76
<i>Sliding, Bends, Hammer-ons, Pull-offs, Tapping & Harmonics</i>	
• Bending the Blues (CD #4 Tr. 6)	78
• Jazz Octaves (CD #4 Tr. 7)	79
• The Funky Mute (CD #4 Tr. 8)	79
15) Electric Guitars-The Heart of Rock & Roll	80
<i>Power Chords, Chicken Pickin', Country Bends, Arpeggios, Sliding 4ths, Harmonized Major Scale</i>	
• Power Chord Rock (CD #4 Tr. 9)	84
• Power Riffs (CD #4 Tr. 10)	84
16) Advanced Strumming	85
<i>16th Notes, Strumming & Exercises</i>	
• Rolling Along (CD #4 Tr. 11)	87
• A Little Bit Rocky (CD #4 Tr. 12)	88
• Electric Funk (CD #4 Tr. 13)	88
17) Going Beyond the First Position	89
<i>3 Note on a String scales, Seventh Chords</i>	
• Triplet Scale Practice (CD #5 Tr. 2,3,4)	91
• Pop Ballad Groove (CD #5 Tr. 5)	92
• ZZ Shuffle (CD #5 Tr. 6)	92
18) Jazz	93
<i>Jazz Chords & Chord Progressions</i>	
• Swingin (CD #5 Tr. 7,8)	96
• Jazz Blues (CD #5 Tr. 9)	97
19) Soloing	98
<i>Soloing Techniques & Ear Training</i>	
• Ear Training Exercises (CD #5 Tr. 10,11,12)	100
• Stevie's Groove (CD #5 Tr. 13)	101
20) All the Chords You Need To Know	102
<i>Chord Formulas, Abbreviations & Inversions</i>	
• Chord Exercise 1 (CD #5 Tr. 14)	104
• Chord Exercise 2 (CD #5 Tr. 15)	105
• Friend (CD #5 Tr. 16)	105
• Funky Groove (CD #5 Tr. 17)	105

SESSION 1- Starting Off Right



Estimated Time to Learn These Concepts - 1 Week

"It's easy to play any musical instrument: all you have to do is touch the right key at the right time and the instrument will play itself."

~ J.S. Bach

The Parts of the Guitar

There are three main types of guitars, the *steel-string acoustic*, the *nylon string or classical guitar*, and the *electric guitar*.

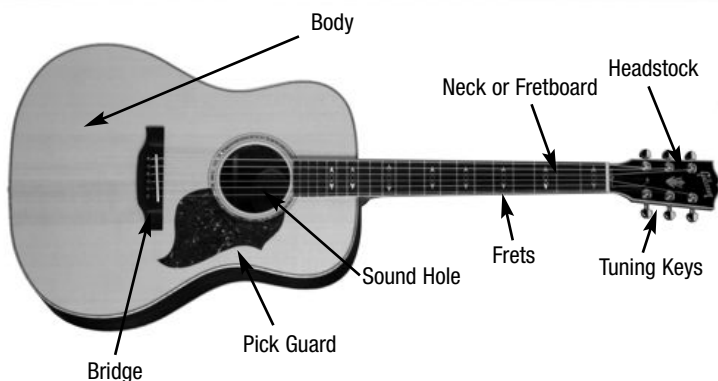

The Names of the Strings

The six strings of a guitar are numbered from first to sixth starting on the thinnest string and counting up to the thickest string. The strings also have letter names that correspond to each string. Memorize the names of your strings.



Proper Right Hand Technique



Hold the pick between your thumb and first finger. The thumb and pick should form a 90 degree angle. The pick should be sticking out from underneath the thumb a 1/4 to 1/2 of an inch.



Hold your thumb on the back of the fingerboard on the upper side of the neck. Be careful not to put your thumb on top of the neck. Your wrist should be low with some air space between your palm and the neck of the guitar.



Bracing your hand gives your hand the needed stability to accurately switch between strings. Although there are many different ways to brace, placing your pinky on the soundboard right below the first string is the most common way. You don't need to press hard.



Your four fingers should be evenly spaced. Notice how the middle two fingers are coming straight onto the fretboard. Your first and fourth fingers are curved slightly toward the frets.

Tuning the Guitar

Your guitar will need to be tuned before playing. Tuning involves tightening or loosening the strings to raise or lower the pitch to match a constant pitch. There are three main ways to tune your guitar. You can tune your guitar by using an electronic tuner, or you can tune by “ear” using the other strings of the guitar, or you can tune to a keyboard.

Tuning with an Electric Tuner

Many electric tuners come with a built in microphone for use with an acoustic guitar. If you are using an electric guitar you can plug your instrument cable directly into the tuner. According to the directions of your specific tuner, it will display whether you need to tighten or loosen the string in order to be in tune. Electric tuners are an easy to use, fast, and accurate way to tune your guitar.



Tuning by Ear

You can also tune your guitar by listening carefully to the other strings and tuning each string to the others. Here is the process.

- Put your finger on the fifth fret of the sixth string. Now, play the sixth string and the open fifth string. Listen to the two pitches. If the open fifth string sounds lower than the sixth string then tighten the fifth string tuning key until the two notes match. If the open fifth string sounds higher than the first note then loosen the fifth string tuning key. You always adjust the tuning keys of the open string, not the string that you are fretting.
- Next, play the fifth fret on the fifth string and the open fourth string underneath it. Listen to the two pitches carefully and adjust the open fourth string accordingly.
- Play the fourth string at the fifth fret. Listen and tune the open third string to it.
- To tune the second string, play the third string at the fourth fret and tune the open second string to it. This is the only string that does not use the fifth fret as the reference.
- Lastly, play the second string fingered back at the fifth fret and tune the open first string to it.

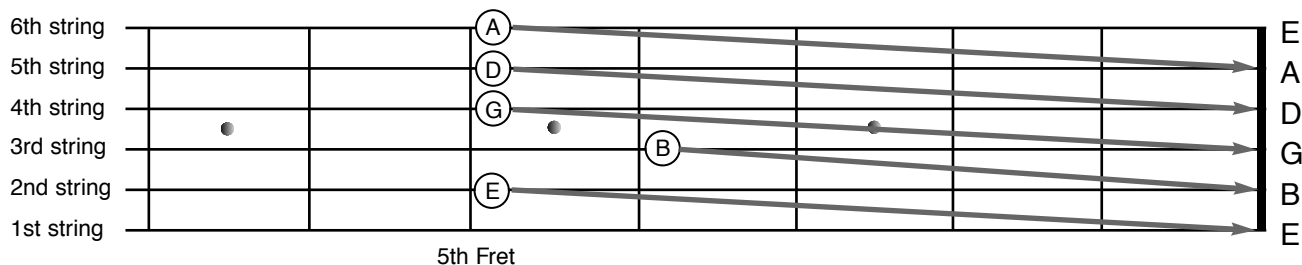

Tuning to a Keyboard

You can also tune your guitar to a keyboard or piano. The open strings of a guitar correspond to certain notes on a keyboard.

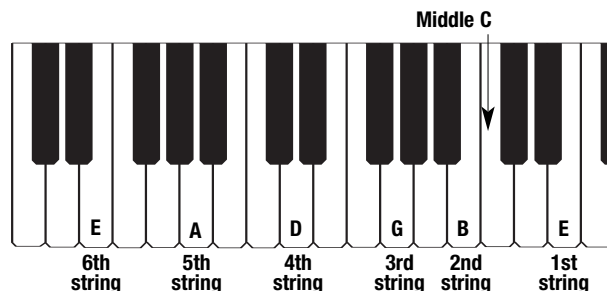

How to Read Guitar Tablature

TABLATURE is a type of musical notation that guitarists have developed to describe what strings on the guitar are being played at any point and what frets need to be fingered.

Figure 1

The Tablature Staff

Strings

1st - E
2nd - B
3rd - G
4th - D
5th - A
6th - E

The 6 lines correspond to the 6 strings on your guitar.

Figure 2

Single Notes in Tablature

The numbers tell you which frets you need to put your fingers on and which strings to use. In this example you would play the first string fretted at the first fret. The next note would be the first string at the third fret. Then, the second string at the third fret and so on.

Figure 3

Chords in Tablature

In this example you would play all of the strings at the same time. The first, second and sixth strings would be open. Your first finger would fret the first fret on the third string. The fourth and fifth strings would have fingers on the second frets of each string.

Finger Exercises

These finger exercises are designed to build coordination between your right and left hand. Proper picking and fingering hand coordination is vital to good controlled guitar playing.

Directions: Play each finger pattern on each string. Start on the first string, then the second, third, etc... Although a little difficult at first, these exercises quickly build the motor skill control needed to play the guitar effectively. Practice with an even, steady rhythm. The goal is control, not speed.

1.

Right Hand Picking: Down-Up-Down-Up

Repeat for all Strings

2.

Right Hand Picking: Down-Up

Repeat for all Strings

3.

Right Hand Picking: All Down

Repeat for all Strings

4. **T** 1 2 1 3 1 4 1 3 1 2 1
A
B

Repeat for all Strings

5. **T**
A
B 4 3 4 2 4 1 4 3 4 2 4 1

Repeat for all Strings

How to Read Chord Blocks

CHORD BLOCKS are diagrams that tell you how a chord is to be played. They include information about which frets are to be played by which fingers and which strings are to be played or not.

Strings ----->
 6th 5th 4th 3rd 2nd 1st
 E A D G B E ← - Nut

1st Fret
 2nd Fret
 3rd Fret
 4th Fret

Chord Name - -> **C**

Don't Play String - -> X ○ ○ ← - Play Strings Open

Put 2nd Finger on 4th String at 2nd Fret → 2
 Put 3rd Finger on 5th String at 3rd Fret → 3

Put 1st Finger on 2nd String at 1st Fret → 1

- An open circle means play the appropriate string open.
- A filled circle means play the note on that particular fret and string.
- An X means to not play that string.

Session 1 Assignment

- Do all finger exercises on all of the strings daily until there is no soreness in fingers and they can be played without hesitation. (pages 4-5)
- Memorize the names of the strings. (page 2)
- Practice the C & G7 chord exercises. Each note should sound out clearly. Try not to hesitate between chords. (page 6)

The C and G7 Chords

The first two chords to be learned are the C and G7. Form and play each chord. The numbers tell you which fingers to use. The C chord uses only 5 strings, so be careful not to play the sixth string. The G7 uses all six strings.

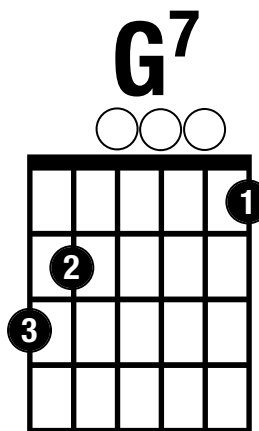
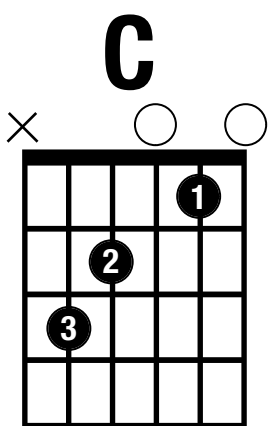

Chord Exercises

1. **C** **G7** **C** **G7** **C**

 ◇ | ◇ | ◇ | ◇ | ◇ |

2. **C** **G7** **C**

 / / / / / | / / / / / | / / / / / | / / / / / | / / / / / |

Strum chord for each slash.

3. **C** **G7** **C** **G7** **C**

 / / / / / | / / / / / | / / / / / | / / / / / | / / / / / |

Strum chord for each slash.

Practicing is the Only Way to Improve

In order to make good progress, you should practice at least 15 minutes a day. If you can do 30 minutes, that would be great. You will only improve with effort. Consistent daily practice yields better results faster.

SESSION 2 - Reading Music & Notes on the 1st & 2nd Strings



Estimated Time to Learn These Concepts - 2 Weeks

"Music is what feelings sound like."
~ Anonymous

How to Read Music

Music is written on a STAFF which has 5 lines and 4 spaces. Music is read from left to right just like you would read a book. Where the note is on the staff tells you how high it is or how low it is in pitch. The note can be on a line or a space. Each line of the staff has a letter name that goes with it. The musical alphabet goes from A to G.

The Music Staff

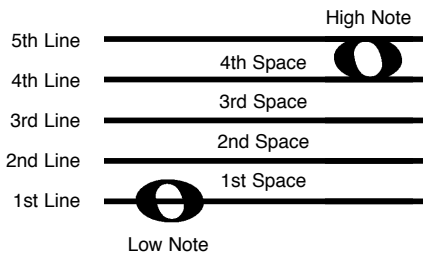

Notes on a Line

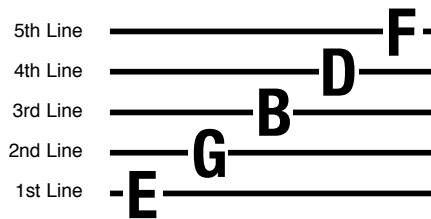

Remember them by learning:
Every Good Boy Does Fine

Notes on a Space

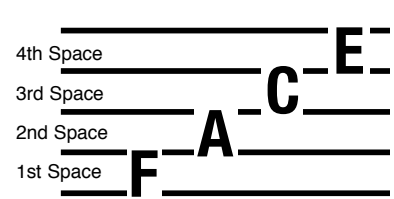

The notes on the spaces conveniently spell the word **FACE**.

Rhythm

There are four main types of notes that vary according to how long they are played.

Types of Notes

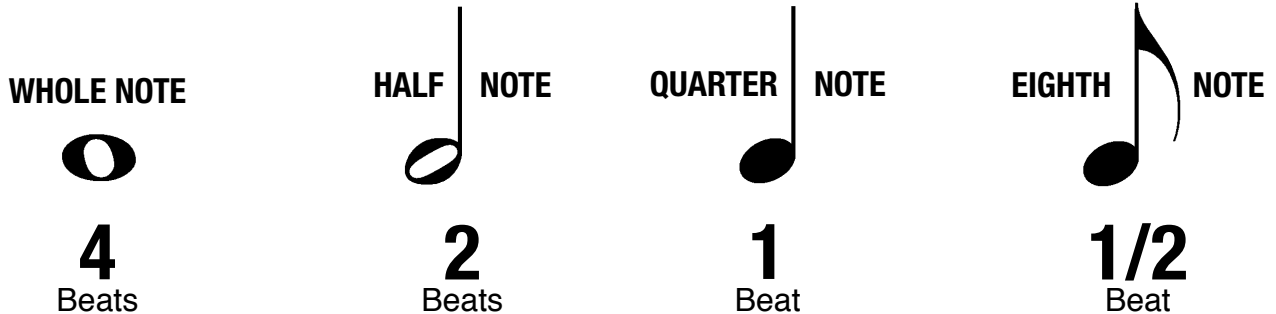

Types of Rests

Music is made up of sound and silence. The notes tell you when to play and the rests tell you when not to play.

WHOLE REST



4

Beats

HALF REST



2

Beats

QUARTER REST



1

Beat

EIGHTH REST



1/2

Beat

Treble Clef, Time Signatures, Barlines & Measures

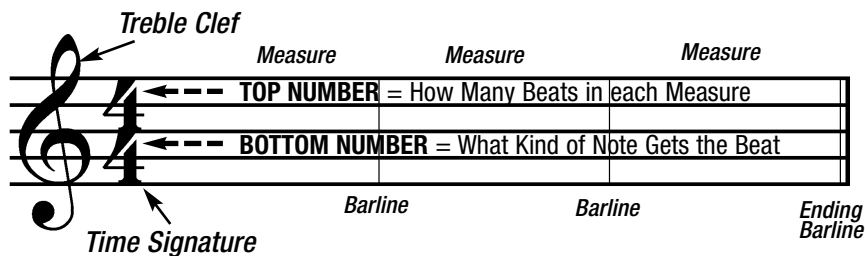

The Notes on the E or First String

E

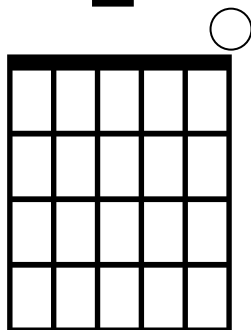

F

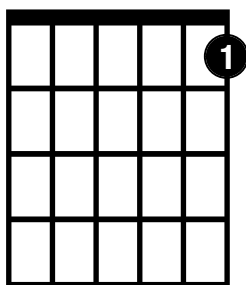

G

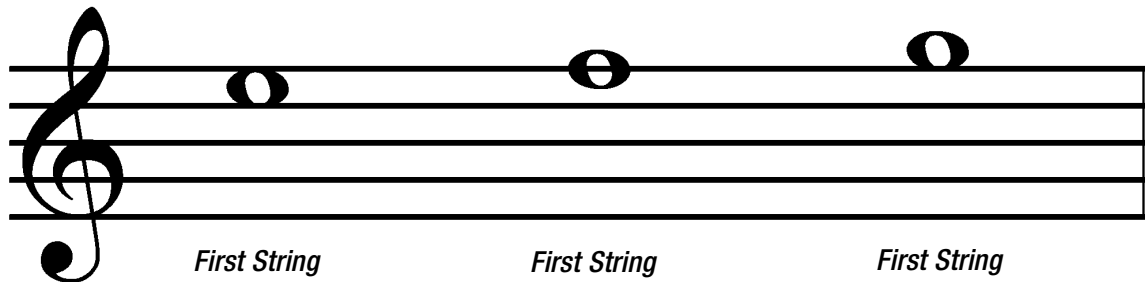
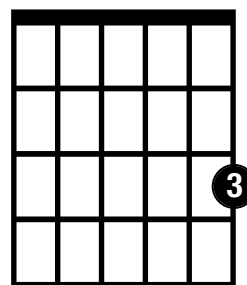

*First String
Open*

*First String
First Finger
First Fret*

*First String
Third Finger
Third Fret*

First String Exercises

Instructions: Write above each note the letter name of the note. Play each exercise using the correct finger for each note.

1.

Whole Notes get 4 Beats.

T
A
B

2.

Half Notes get 2 Beats.

T
A
B

3.

Quarter Notes get 1 Beat.

T
A
B

4.

T
A
B

More First String Exercises

Instructions: These exercises do not have the tablature included. Try to read the music and play slowly. Write in the notes if needed. Play each exercise. Remember to use the correct finger for each note.

1. 
2. 
3. 
4. 
5. 

Continue to next line.



The Notes on the B or Second String

B

C

D

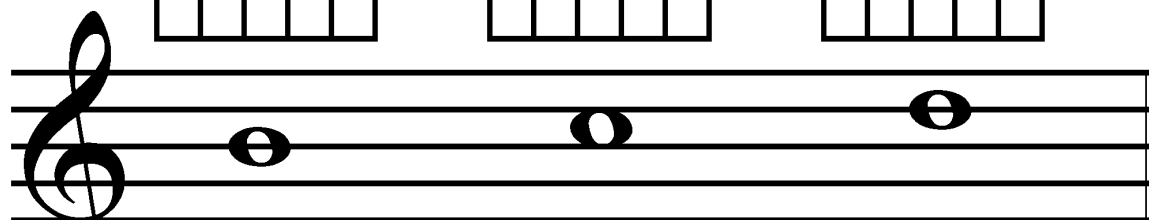
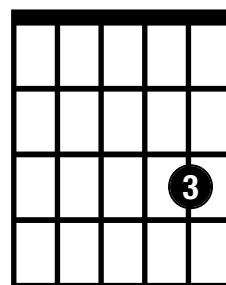
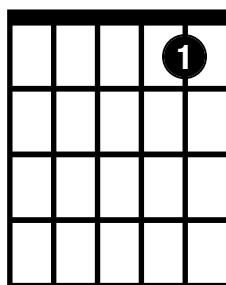
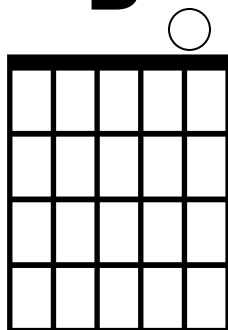

*Second String
Open*

*Second String
First Finger
First Fret*

*Second String
Third Finger
Third Fret*

Second String Exercises

Instructions: Write above each note the letter name of the note. Play each exercise using the correct finger for each note. Practice slowly. Remember to give each note the proper number of beats.

1.

T	0	1	3	0	3	0	1
A							
B							

2.

T	0	1	0	3	1	3	1	0
A								
B								

3.

T	0	0	1	1	3	1	0	0	1	3	3	1	0	1	3
A															
B															

4.

T	3	0	1	0	0	0	1	1	1	0	0	0	3	1	0	1	3	0	3
A																			
B																			

More Second String Exercises

Instructions: Try to read the music and play slowly in an even rhythm. Write in the notes if needed. Play through each exercise until there is no hesitation between notes.

1.

2. 

3. 

4. 

5. 



First and Second String Exercises

Instructions: Play each exercise slowly in an even, steady rhythm. Be careful to use the correct finger for each note.

1. 

T 0 1 3 1 0 0 1 3 1 0 1 3 0 1 3 3 1

A

B

2. 

T 1 1 0 0 3 3 1 1 0 3 1 0 3 1

A

B

3. 

T 0 0 1 1 3 1 0 0 1 3 3 1 0 1 3

A

B

4.

T 0 1 3 0 1 3 1 0 3 1 0 1 0 3 0 3 1 0 1

A

B

More First and Second String Exercises

Instructions: Try to read the music and play slowly in an even rhythm. Write in the notes if needed. Play through each exercise until there is no hesitation between notes.

1.

2.

Quarter rest, 1 Beat.

3.

Half rest, 2 Beats.

4.

5.

6.

Session 2 Assignment

- Play through all of the First and Second String Exercises several times. (pages 9-13)
- Play Ode To Joy, both notes and chords. Write in letter names of notes. (page 14)
- Play Jingle Bells, both notes and chords. Write in letter names of notes. (page 15)

Theme from Symphony #9

Ode to Joy

Ludwig van Beethoven
(1770-1827)

Jam Along CD #1

Track 2 - Slow Version

Track 3 - Medium Version

Track 4 - Fast Version

Play the notes then practice strumming the correct chord for each beat. If a measure does not have a chord change over it then continue to play the previous chord until the chord changes.

Chord diagrams: C, G7, C, G7

Joy - ful, joy - ful we a - dore thee, God of glo - ry, Lord of love;

T
A
B

Chord diagrams: C, G7, C, G7, C

Hearts un - fold like flowers be - fore thee, Prais - ing thee, their sun a - bove.

T
A
B

Chord diagrams: G7, C, G7

Melt the clouds of sin and sad - ness, drive the dark of doubt a - way;

T
A
B

Chord diagrams: C, G7, C, G7, C

Giv - er of im - mor - tal glad - ness, Fill us with the light of day.

T
A
B

Jam Along CD #1
Track 5 - Slow Version
Track 6 - Medium Version
Track 7 - Fast Version

Jingle Bells

C





4/4

Jin - gle bells, jin - gle bells jin - gle all the way. —

0 0 0 0 0 0 0 3 1 3 0

T
A
B

G7 **C** **G7**





Oh, what fun it is to ride in(a) one horse o - pen sleigh. —

1 1 1 1 1 0 0 0 0 3 3 0 3 3

T
A
B

C







Jin - gle bells, jin - gle bells jin - gle all the way. —

0 0 0 0 0 0 0 3 1 3 0

T
A
B

G7 **C** **G7** **C**

Oh, what fun it is to ride in(a) one horse o - pen sleigh. —

1 1 1 1 1 0 0 0 3 3 1 3 1

T
A
B

SESSION 3 - Notes on the 3rd & 4th Strings



Estimated Time to Learn These Concepts - 2 Weeks

"I would teach children music, physics, and philosophy; but most importantly music, for in the patterns of music and all the arts are the keys of learning."

~ Plato

Ties

A TIE combines the rhythmic values of two notes and is represented by a curved line between two notes of the same pitch. The first note is played for the duration of both notes and the second note is not played.

1.

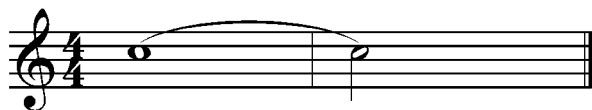

2.



Dots

A DOT following a note changes the rhythmic value of the note. DOTS add one half of whatever note value they are attached to.

DOTTED HALF NOTE



3
Beats
(2+1)

DOTTED WHOLE NOTE



6
Beats
(4+2)

DOTTED QUARTER NOTE



1 1/2
Beats
(1+1/2)

Repeat Signs

A REPEAT SIGN is a double bar line with two dots. It means to repeat a section of music. You would repeat back to where a previous backwards repeat sign was or to the beginning of the song, whichever comes first.



Repeat back to beginning

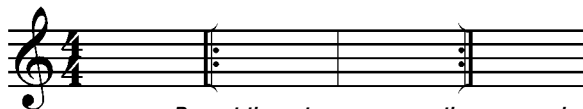

Repeat these two measures then proceed on

Eighth Notes

An EIGHTH NOTE receives 1/2 a beat so it takes two of them to make 1 beat. If you have several eighth notes together, they are grouped together by a beam.

EIGHTH NOTE



1/2
Beat

EIGHTH NOTES BEAMED TOGETHER

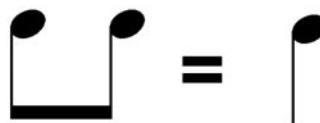

Eighth Note Exercises

Instructions: Play slowly in an even rhythm. Write in the notes if needed. Play through each exercise. Try not to hesitate between notes. When you have several eighth notes of the same pitch in a row, then alternate your picking (Down-Up-Down-Up).

1.

2.

3.

4.

5.

6.

The Notes on the G or Third String

G

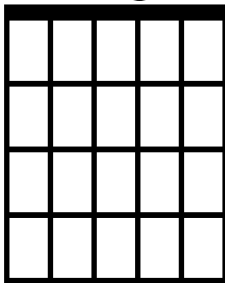

A

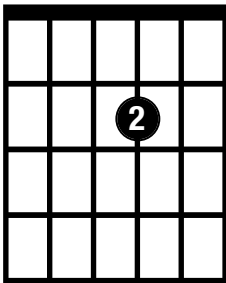

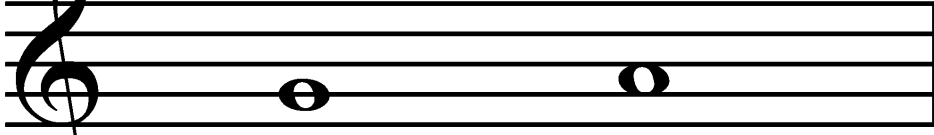

Third String
Open
Third String
Second Finger
Second Fret

Third String Exercises

Instructions: Play each exercise using the correct finger for each note. Write in the notes if needed.

1.



2.



3.



4.

The Notes on the D or Fourth String

D

E

F

*Fourth String
Open*

*Fourth String
Second Finger
Second Fret*

*Fourth String
Third Finger
Third Fret*

Fourth String Exercises

Instructions: Play each exercise using the correct finger for each note. Write in the notes if needed.

1.

2.

T
A
B

0 0 0 2 2 2 | 3 2 3 | 3 3 3 3 2 2 2 2 | 0 2 0

3.

T
A
B

3 2 3 3 | 2 0 2 2 | 0 2 0 0 | 0 2 3 2 0

4.

T
A
B

0 2 3 0 2 0 1 3 | 0 1 3 3 1 0 3 | 1 0 2 0 3 2 0

Session 3 Assignment

- Play through the Eighth Note Exercises until they can be played without hesitation. (page 17)
- Play through all of the Third and Fourth String Exercises several times. (pages 18-20)
- Play Yankee Doodle, both notes and chords. Write in letter names if you need to. (page 21)
- Play When The Saints Go Marchin' In. (page 21)
- Play Aura Lee. (page 22)

Jam Along CD #1
Track 8 - Slow Version
Track 9 - Medium Version
Track 10 - Fast Version

Yankee Doodle

C **G7**

Yan - kee - Doo - dle went to town a - ri - ding on a po - ny. He
 stuck a fea - ther in his cap and called it mac - a - ro - ni.

Jam Along CD #1
Track 11 - Slow Version
Track 12 - Medium Version
Track 13 - Fast Version

When The Saints Go Marchin' In

This song includes chords that are covered in Session 5 (page 31).

G **D7** **G** **C** **G** **C** **D** **G**

Oh when the saints _____ go march - ing in _____
 oh when the saints go march - ing in _____ Lord, I
 want to be in that num - ber _____ when the
 saints go march - ing in _____

Aura Lee

This song includes chords that are covered in Session 5 (page 31).

 **Jam Along CD #1**
Track 14 - Slow Version
Track 15 - Medium Version
Track 16 - Fast Version

The musical score for 'Aura Lee' is presented in three staves, each with a treble clef and a 4/4 time signature. The first staff contains four measures of music with chords C, D7, G, and C above them. The second staff contains four measures with chords C, E7, Am, and E7. The third staff contains five measures with chords C, A7, D7, G, and C. Each chord is accompanied by a guitar chord diagram showing the fingerings on the strings.

SESSION 4- Notes on the 5th & 6th Strings



Estimated Time to Learn These Concepts - 4 Weeks

"Playing guitar is an endless process of running out of fingers."

~ Harvey Reid, *Fingerstyle Guitarist*



The Notes on the A or Fifth String

A **B** **C**

Fifth String Open **Fifth String Second Finger Second Fret** **Fifth String Third Finger Third Fret**

The Notes on the E or Sixth String

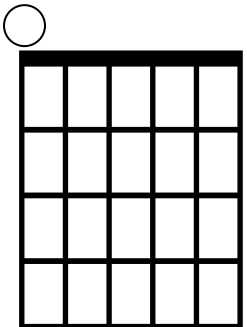
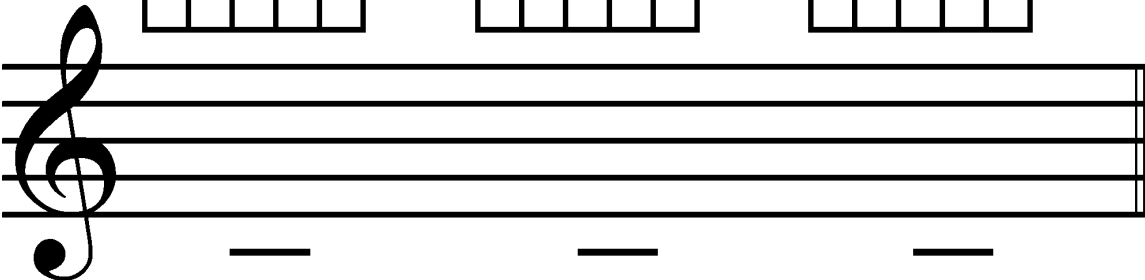
E



Sixth String
Open

F

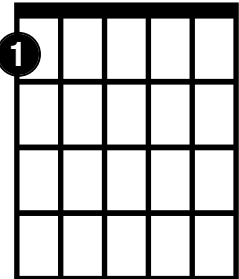
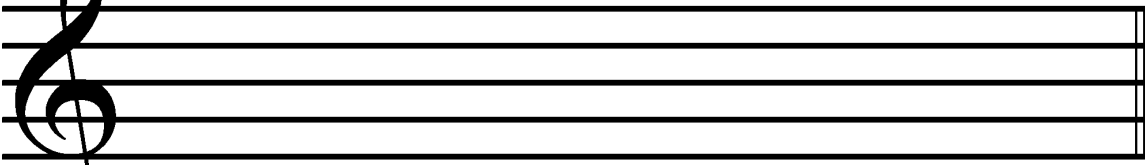
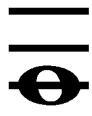
Sixth String
First Finger
First Fret

G

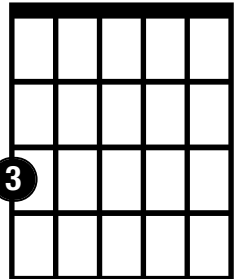
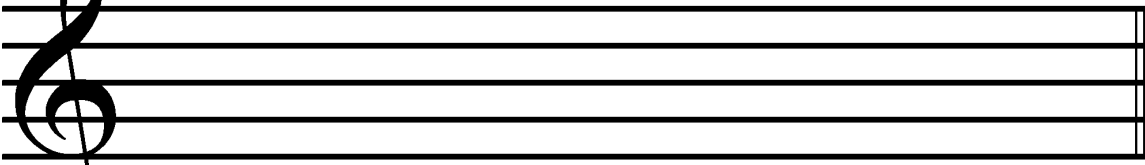



Sixth String
Third Finger
Third Fret

Fifth and Sixth String Exercises

Instructions: Play each exercise using the correct finger for each note. Write in the notes if needed.

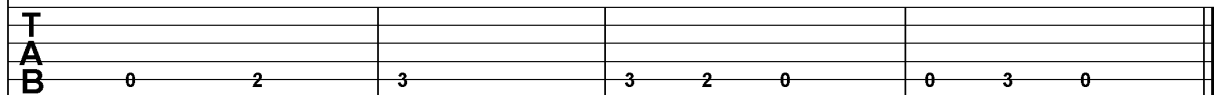
1.

2.

3.

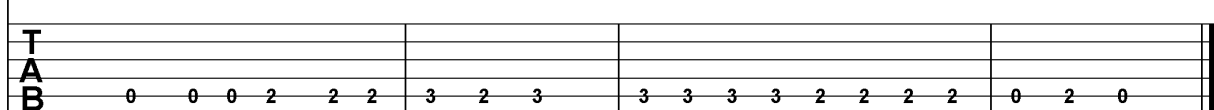
T
A
B

0 1 3 3 1 0 0 0 1 1 3 0 1 3 1 0

4.

T
A
B

0 1 3 0 2 3 0 2 3 0 2 3 0 1 3 3 3 3 1 3 1 0 2 0 3 2 0 3 2 0 3 1 0

Notes in the First Position

E F G A B C D E F G A B C D E F G

T
A
B

0 1 3 0 2 3 0 2 3 0 2 0 1 3 0 1 3

6th String 5th String 4th String 3rd String 2nd String 1st String

C Major Scale Example

Jam Along CD #1
Track 17 - Slow Version
Track 18 - Medium Version
Track 19 - Fast Version

Minuet in C

J.S. Bach
 (1685-1750)

Sharps, Flats, and Natural Signs

Sharps

SHARPS raise up any note one half-step or one fret. The sharp sign appears before the note that is to be sharped. Remember to use the correct finger for each fret.

Flats b

FLATS lower any note one half-step or one fret.

Open String Flat Rule: When flattening an open string go to the next lower string and play the fourth fret with your fourth finger. The one exception to this rule is the Bb on the third string third fret.

A sharp or a flat affects not just the note it is by, but every note of the same name that follows it for the entire measure.

Example

Naturals 

A NATURAL SIGN cancels out a previously used sharp or flat and restores it to its normal position.

The A Minor and E Chord

Am

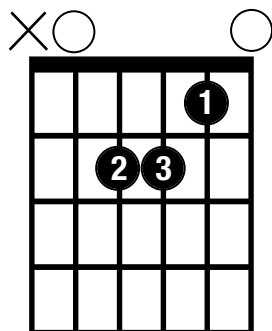

E

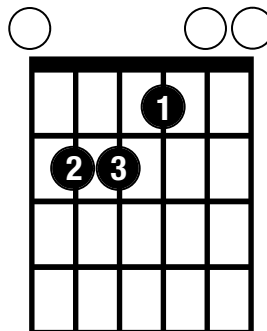

Chord Exercises

1. Am | E | Am | E | Am ||

2. C | Am | E | G7 | C ||

3. C Am G7 E Am C

 / / / / | / / / / | / / / / | ◇ ||

Session 4 Assignment

- Play through all of the Fifth and Sixth String Exercises several times. (pages 24-25)
- Play through and memorize the Notes in the First Position. (pages 25)
- Play Minuet in C. (page 26)
- Play Simple Gifts. (page 28)
- Play The Star Spangled Banner. (page 29)
- Play Minuet in G. (page 30)

 **Jam Along CD #1**
Track 20 - Slow Version
Track 21 - Medium Version
Track 22 - Fast Version

Simple Gifts

All F's are sharped throughout the whole song.

Key Signature = F#



 **Jam Along CD #1**
Track 23 - Slow Version
Track 24 - Medium Version
Track 25 - Fast Version

The Star Spangled Banner

Francis Scott Key & John Stafford Smith



Oh, — say, can you see, by the dawn's ear - ly light, what so



proud - ly we hailed — at the twi - light's last gleam - ing? Whose broad stripes and bright



stars, through the per - i - lous fight, — o'er the ram - parts we watched, were so



gal - lant - ly stream - ing? And the rock - et's red glare, — the bombs burst - ing in

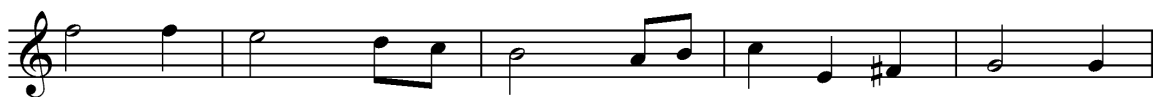

air, — gave proof through the night that our flag was still there. O



say, does that — star spang - led ban - ner — yet — wa - ve. O'er the



land — of the free and the home of the brave?

 **Jam Along CD #1**
Track 26 - Slow Version
Track 27 - Medium Version
Track 28 - Fast Version

Minuet in G

J.S. Bach
(1685-1750)

Key Signature = F#
All F's are sharpened throughout
the whole song.



The musical score for "Minuet in G" by J.S. Bach is presented in eight staves of music. The key signature is one sharp (F#), and the time signature is 3/4. The music is written in treble clef. The notation includes various rhythmic values such as quarter notes, eighth notes, and sixteenth notes, along with rests and accidentals (sharps). The piece concludes with a double bar line.

SESSION 5 - Basic Open Chords



Estimated Time to Learn These Concepts - 3 Weeks

"Being good is not about playing fast, it's about thinking fast."

~ Anonymous

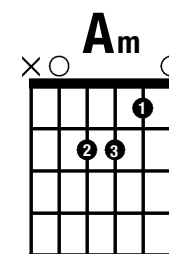
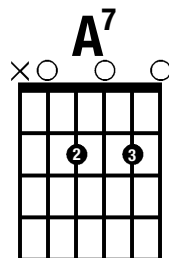
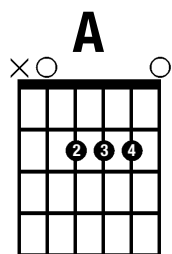
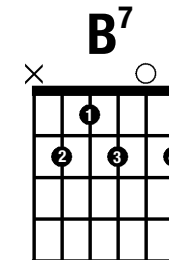
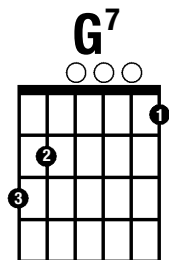
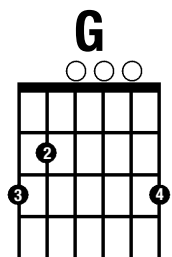
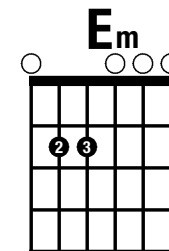
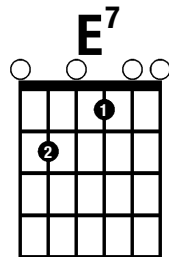
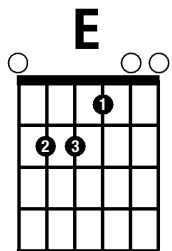
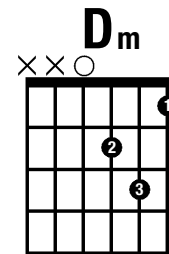
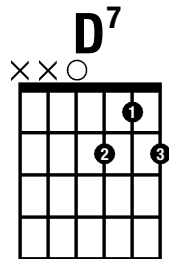
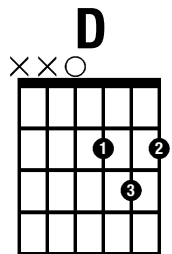
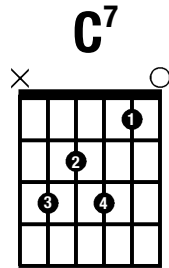
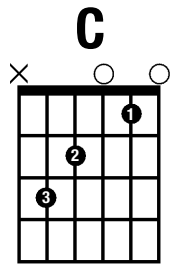

Basic Open Chord Exercises - 1

Learning the C, G7, Am, E, & Dm chords

1.

C



This chord uses 5 strings.

G7



This chord uses 6 strings.

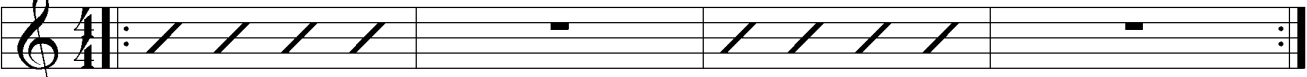

Strum chord for each beat.

2.

Am



5 string chord

E



6 string chord

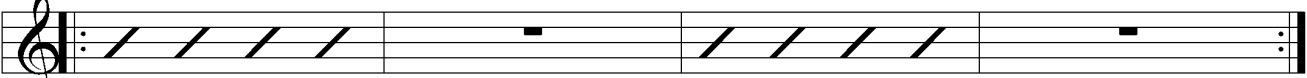

3.

C



Am



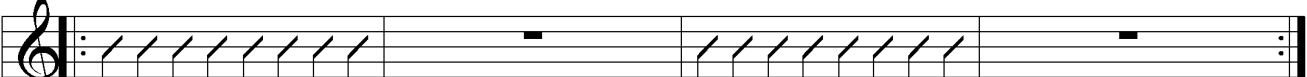



Strum chord down & up for each eighth note pair.

4.

Am



Dm



4 string chord

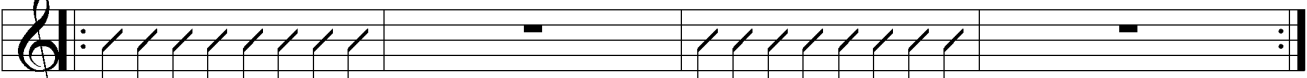

5.

Dm



G7



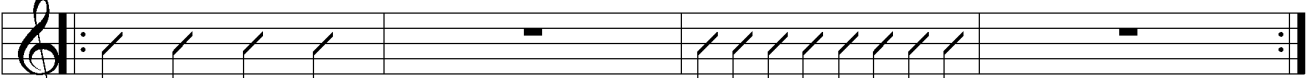

6.

C



Am



Dm



G7



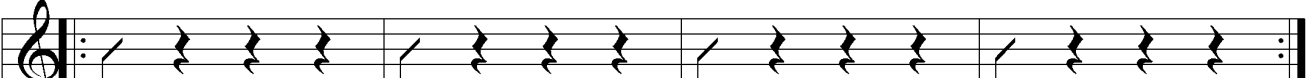

Basic Open Chord Exercises - 2

Learning the G, D7, Em, & B7 chords

1. **G** 6 string chord **D7** 4 string chord

2. **C** **D7**

3. **B7** 5 string chord **Em** 6 string chord

Use your finger tips to get all of the notes to sound properly.

4. **Am** **B7**

5. **G** **Em**

Watch your rhythm carefully!

6. **G** **D7** **Em** **B7**

Basic Open Chord Exercises - 3

Learning the D, C7, A, A7 & E7 chords

1. **D** 4 string chord **A** 5 string chord

2. **C7** 5 string chord **A7** 5 string chord

3. **Em** **A7** **Em** **B7**

4. **A** **D** **E** **E7** 6 string chord

5. **G** **Em** **C7** **D7**

6. **C** **Dm** **Am** **G7**

Change chords quickly to not break the rhythm.

Session 5 Assignment

- Memorize the Basic Open Chord Forms. (page 31)
- Play through Basic Chord Exercises 1, 2 & 3. (pages 32-34)
- Play Morning Has Broken, both notes and chords. (page 35)
- Play America the Beautiful. (page 36)

 **Jam Along CD #2**
Track 2 - Slow Version
Track 3 - Medium Version
Track 4 - Fast Version

Morning Has Broken

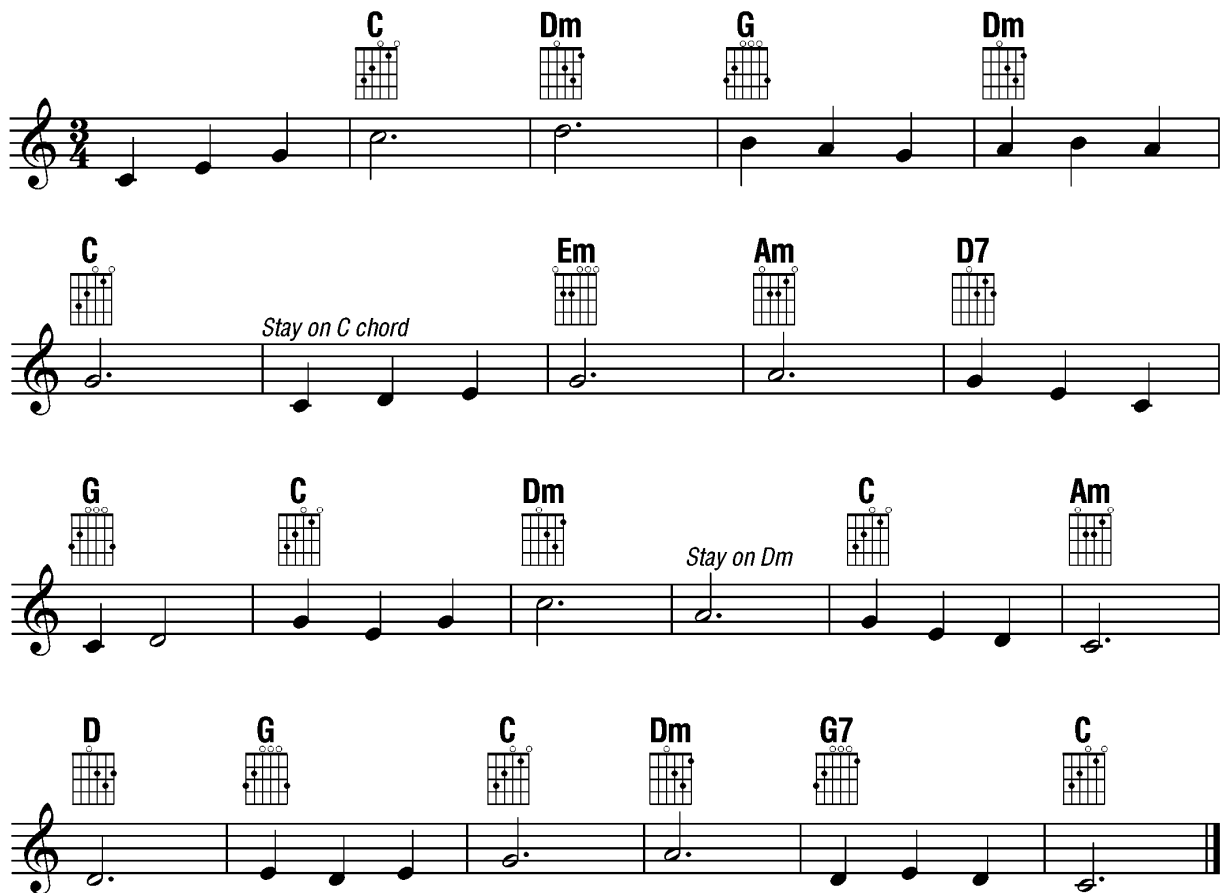

The musical score for "Morning Has Broken" is presented in four systems, each with a treble clef and a 3/4 time signature. Chord diagrams are placed above the notes they apply to. The first system has chords C, Dm, G, and Dm. The second system starts with a C chord, followed by a measure with the instruction "Stay on C chord", then Em, Am, and D7. The third system has G, C, Dm, a measure with "Stay on Dm", C, and Am. The fourth system has D, G, C, Dm, G7, and C.

Jam Along CD #2
Track 5 - Slow Version
Track 6 - Medium Version
Track 7 - Fast Version

America The Beautiful

Key Signature = F#
**All F's are sharpened throughout
the whole song.**

Samuel A. Ward

G **D7**

O beau - ti - ful for spa - cious skies, For am - ber waves of

G **D7**

grain. — For pur - ple moun - tains maj - es - ties A -

E7 **A7** **D7** **G**

bove the fruit - ed plain. A - mer - i - ca A -

D **D7** **Am** **D7** **G**

mer - i - ca God shed His grace on thee. — And

C **G** **Am** **D7** **G**

crown thy good with broth - er - hood from sea to shin - ing sea.

SESSION 6 - Minor Seventh & Suspended Chords



Estimated Time to Learn These Concepts - 2 Weeks

"If music be the food of love, play on."
~ William Shakespeare

Open Minor Seventh Chords

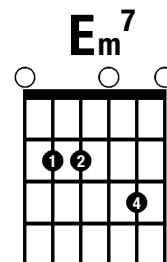
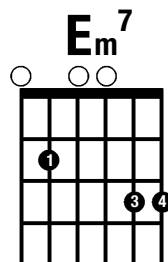
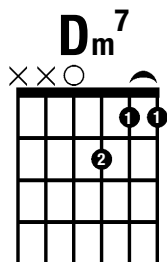
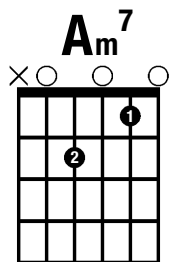

Alternate Fingering

Open Suspended Chords

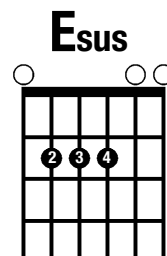
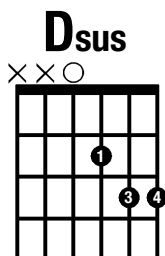
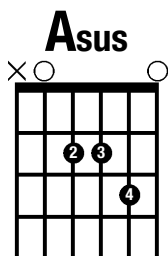

Minor Seventh Chord Exercises

Practicing the Am7, Dm7, & Em7 chords.

1.

2.

3.

Strumming with Ties Exercises

	Strumming Pattern Without Tie	Strumming Pattern With Tie
1.	<p>Down Down Up Down</p>	<p>Down Down Up</p>
2.	<p>Down Down Up Down Up Down</p>	<p>Down Down Up Up Down</p>
3.	<p>Down Up Down Up Down</p>	<p>Down Up Down Up</p>

Suspended Chord Exercises

Practicing the Asus, Dsus, & Esus chords.

1.	<p>A</p>	<p>Asus</p>	<p>D</p>	<p>Asus</p>
2.	<p>D</p>	<p>Dsus</p>	<p>G</p>	<p>Dsus</p>
3.	<p>E</p>	<p>Esus</p>	<p>E</p>	<p>Esus</p>

Three Basic Strumming Patterns

1.	2.	3.

Open Chords in the Key of C

Practicing the C, Am, Am7, Dm, Dm7, G7, G, Em and Em7 chords

1. **C Dm C G7**

2. **C Am G Em**

3. **C Am Dm7 G7**

4. **Am7 Em7 G C**

5. **C Em Am Dm**

6. **C Am7 G G7**

Open Chords in the Key of G

Practicing the G, Am, Am7, C, D, D7, Dsus, Em & Em7 chords

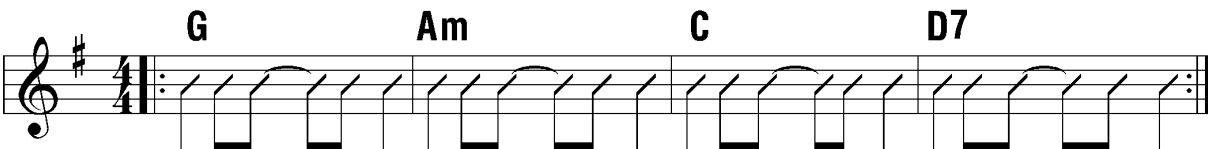
1.  **G Am C D7**

2.  **G Em Am7 Dsus**

3.  **G Em7 Am D**

4.  **Em Am7 Dsus D7**

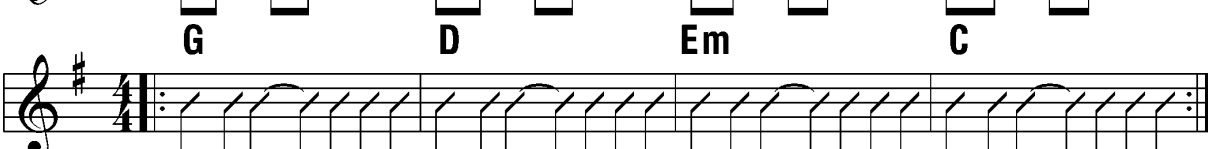
5.  **G D Em C**

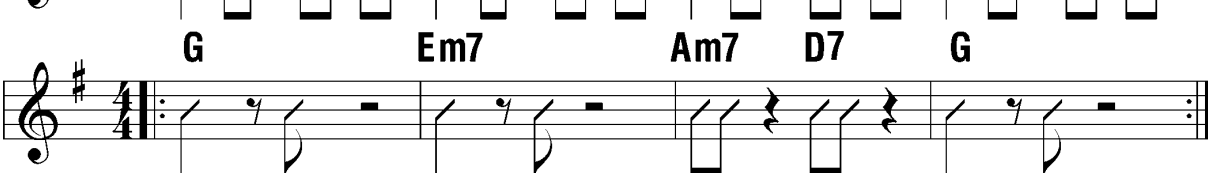
6.  **G Em7 Am7 D7 G**

Open Chords in the Key of D

Practicing the D, D7, Em, Em7, G, G7, A, A7 and Asus chords

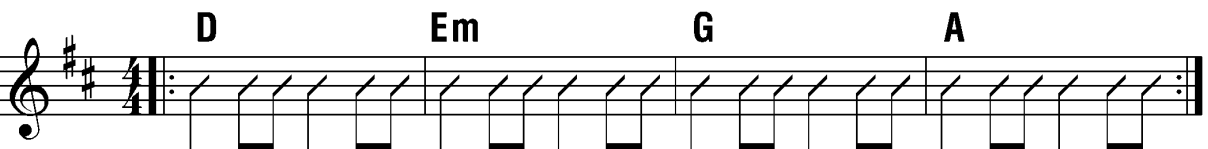
1.  **D Em G A**

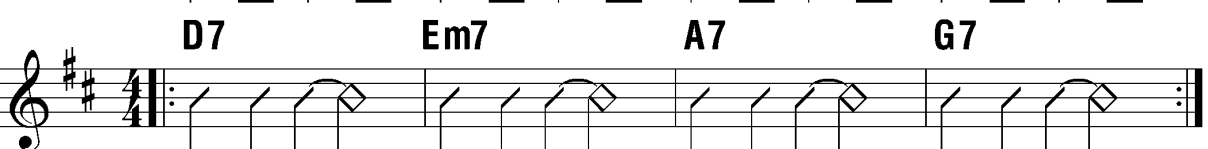
2.  **D7 Em7 A7 G7**

3.  **D G Asus A**

4. **D A7 Em7 G**

5. **Em G Asus D**

6. **D G A G D G A G**

Session 6 Assignment

- Memorize the Open Minor Seventh and Suspended Chord Forms. (page 37)
- Play through the Chord Exercises in the Key of C, G, and D. (pages 39-41)
- Play Scarborough Fair, both notes and chords. (page 41)
- Play Greensleeves, both notes and chords. (page 42)
- Play Island Groove, both notes and chords. Use the given strumming pattern. (page 42)

 **Jam Along CD #2**
Track 8 - Slow Version
Track 9 - Medium Version
Track 10 - Fast Version

Scarborough Fair

Strumming Pattern

Em Em7 D Em Em7

Are you go - ing to Scar - bor - ough Fair?

G Em A Em7 Em

Par - sley, sage, rose - mar - y and thyme. Re -

G Em D

mem - ber me to the one who lives there,

Em A D Em

She once was a true love of mine.

Jam Along CD #2
Track 11 - Slow Version
Track 12 - Medium Version
Track 13 - Fast Version

Greensleeves

Strumming Pattern

Am7 D7 G Em Am7

Em Am7 D7 G Em

Am E7 Am C G

Em Am7 Em C

G Am E7 Am

Jam Along CD #2
Track 14 - Slow Version
Track 15 - Medium Version
Track 16 - Fast Version

Island Groove

Strumming Pattern

G D7 G D7 G

G D7 G

G D7 G

SESSION 7 - Barre Chords on the 6th String



Estimated Time to Learn These Concepts - 2-3 Weeks

"If I were not a physicist, I would probably be a musician. I often think in music. I live my daydreams in music. I see my life in terms of music. . . . I get most . . . in life out of music."
 ~ Albert Einstein

Half-Steps & Whole Steps

A HALF-STEP is the distance from any note to the very next note. A WHOLE STEP is two half-steps put together. On a guitar, each fret is a half-step apart. On a piano, each key, whether white or black, is a half-step apart from the next key. Even though some white keys on a piano are next to each other, often they will have a black key in between them. The distance from the first white key to the in-between black key is a half-step. From a white key to another white key, with a black key in between, is a whole step.

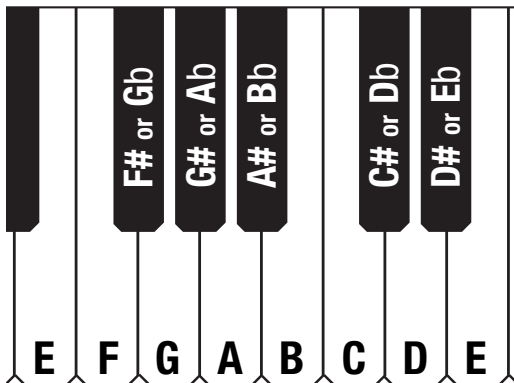

The only naturally occurring half-steps are between E to F and B to C.

Naturally occurring means that without using sharps or flats the intervals of E to F and B to C are the only adjacent pairs that are half-steps. Between these two intervals there is only a half-step difference. All of the other pairs of adjacent notes, without sharps or flats involved, are whole steps.

On our keyboard there are no black keys between E - F and B - C. On a guitar, each of these two pairs of notes are side by side with no note in between them.

Notes on the Sixth String

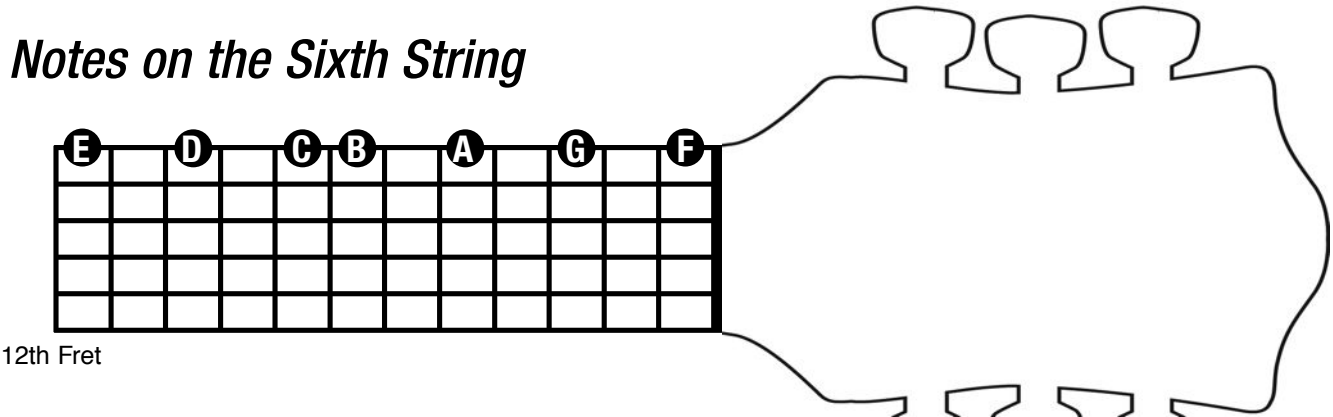

Sixth String Barre Chords

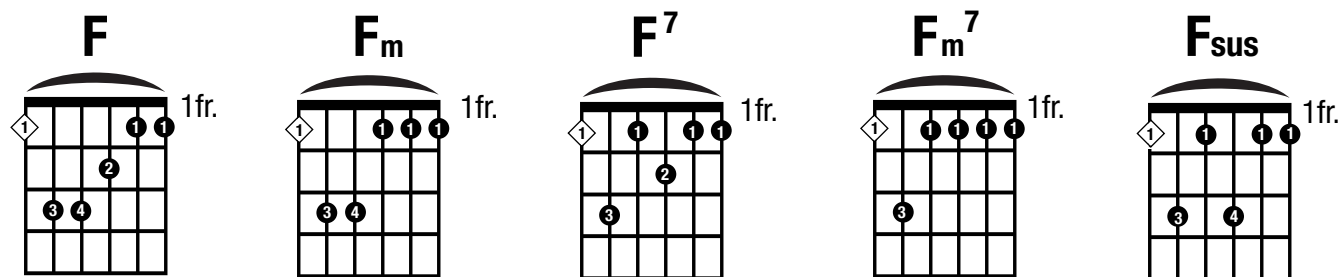

The "1fr." means to play that chord starting at the first fret. The arcs mean to cover all of the strings with one finger. When you use one finger to cover more than one string it is called a BARRE. The note with a diamond is the root of the chord and the note that you will pivot from to move the chord into different keys.

Sixth String Barre Chord Exercises

Learning the moveable F, F7, Fm, Fm7 & F_{sus}

- 1.** *Make sure each note of the chord is sounding clearly.*

F G A B^b
- 2.**

G Am Bm C
- 3.**

A F[#]m7 Bm Am G_{sus} G A
- 4.** *Repeat the same rhythm.*

B^b Cm F7 B^b Gm Cm F_{sus} F7 B^b
- 5.**

F B^b Gm7 C_{sus} C7 F
- 6.**

G Bm C Bm Am F F[#] G

Major Scales

MAJOR SCALES are the building blocks for all of music. Major scales are built on a specific pattern of half-step and whole-step intervals. The pattern for a major scale is **Whole-step, Whole-step, Half-step, Whole-step, Whole-step, Whole-step, Half-step**. Starting on any note, if you follow this pattern you will build a major scale in the note's key.

Directions: Fill in major scale notes following the interval pattern. Determine the number of sharps or flats. List sharps or flats in order. I have filled in some of the spaces for you.

✓ Check your answers at www.LearnandMasterGuitar.com/answerkey

	<i>Whole</i>	<i>Whole</i>	<i>Half</i>	<i>Whole</i>	<i>Whole</i>	<i>Whole</i>	<i>Half</i>	<i>How many #'s or b's?</i>	<i>What are they?</i>
C	<u>D</u>	<u>E</u>	___	___	___	___	___	none	_____

The following scales all contain SHARPS.

G	___	___	___	___	___	<u>F#</u>	___	___	<u>F#</u> , _____
D	___	<u>F#</u>	___	___	___	<u>C#</u>	___	___	<u>F#</u> , <u>C#</u> , _____
A	___	___	___	___	___	___	___	<u>3 #'s</u>	_____
E	___	___	___	___	___	___	___	___	_____
B	___	___	___	___	___	___	___	___	_____
F#	___	___	___	___	___	<u>E#</u>	___	___	_____

The following scales all contain FLATS.

F	___	___	<u>Bb</u>	___	___	___	___	___	_____
Bb	___	___	___	___	___	___	___	___	_____
Eb	___	___	<u>Ab</u>	___	___	___	___	<u>3 b's</u>	_____
Ab	___	___	___	___	___	___	___	___	<u>Bb</u> , <u>Eb</u> , <u>Ab</u> , <u>Db</u>
Db	___	___	___	___	___	___	___	___	_____
Gb	___	___	<u>Cb</u>	___	___	___	___	___	_____

Major Scale Table

Major Scales are the foundation upon which all of the upcoming theory is going to be built. Just like multiplication tables need to be memorized, major scales and the key signatures that they generate have to be learned and memorized. KEY SIGNATURES are the pattern of sharps or flats that each major scale generates.

Directions: Fill in the major scale notes on the following table. Remember, the naturally occurring half-steps are between E-F and B-C.

✓ Check your answers at www.LearnandMasterGuitar.com/answerkey

	Whole Step	Whole Step	Half Step	Whole Step	Whole Step	Whole Step	Half Step
C	D						
F		A					
B_b			E_b				
E_b				B_b			
A_b					F		
D_b						C	
G_b							G_b
F_#						E_#	
B					G_#		
E				B			
A			D				
D		F_#					
G	A						

Session 7 Assignment

- Memorize the Notes on the Sixth String. (page 43)
- Memorize the 6th String Barre Chord Forms. (page 44)
- Play through 6th String Barre Chord Exercises. Make sure each chord is sounding clear and that the chords change at the right time. (page 44)
- Play Home on the Range, both notes and chords. Try to use all barre chords. (page 47)
- Play Yellow Rose of Texas, both notes and chords. (page 47)
- Complete the Major Scale and the Major Scale Table Worksheets. (pages 45-46)

Jam Along CD #2
Track 17 - Slow Version
Track 18 - Medium Version
Track 19 - Fast Version

Home on the Range

Practice using a mixture of open and barre chords and then practice using all barre chords.

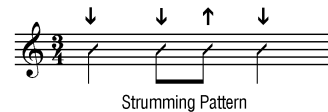

Oh, give me a home where the buf - fa - lo roam. Where the deer and the
 an - te - lope play. Where sel - dom is heard a dis - cour - a - ging
 word and the skies are not clou - dy all day.
 Home, home on the range. where the deer and the
 an - te - lope play. Where sel - dom is heard a dis -
 cour - a - ging word and the skies are not clou - dy all day.

Jam Along CD #2
Track 20 - Slow Version
Track 21 - Medium Version
Track 22 - Fast Version

Yellow Rose of Texas

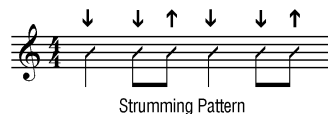

There's a yel - low rose in Tex - as I'm go - ing there to see. No oth - er fel - low
 knows her. No - bod - y on - ly me. She cried so when I left her. It liked to broke her
 heart. And if we ev - er meet a - gain, we nev - er - more shall part.

SESSION 8 - Barre Chords on the 5th String

 Estimated Time to Learn These Concepts - 2-3 Weeks

"Music should be something that makes you gotta move, inside or outside."
~ Elvis Presley

Notes on the Fifth String

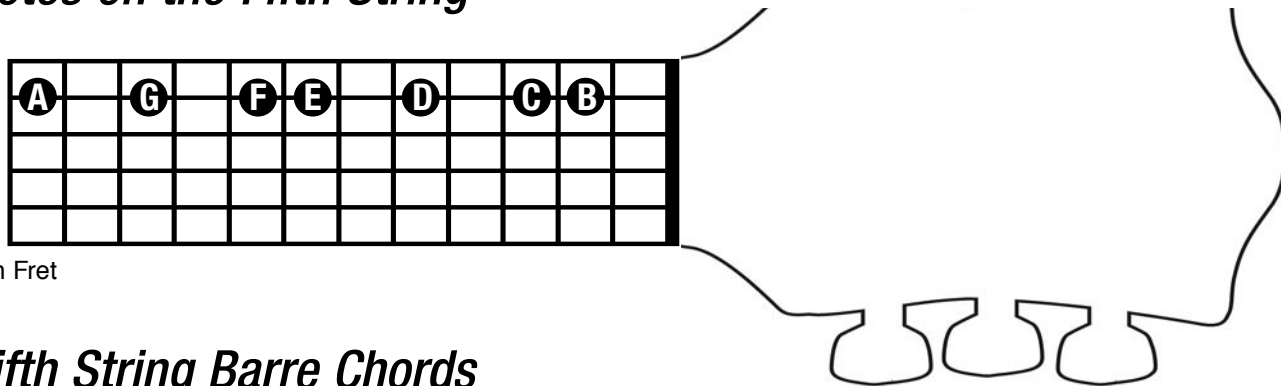

12th Fret

Fifth String Barre Chords

B	B	B_m	B⁷	B_m⁷	B_{sus}

Alternate Fingering

Fifth String Barre Chord Exercises

Learning the moveable B, B_m, B⁷, B_m⁷ & B_{sus}

- B_m Cm Dm Em**

Make sure each note of the chord is sounding clearly.
- B_m C B_m D**
- D B_m⁷ D Em⁷ C D**

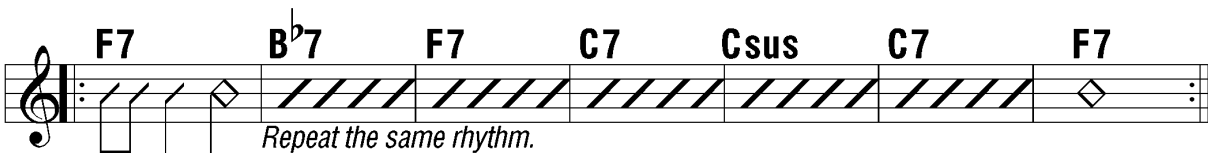
4. 

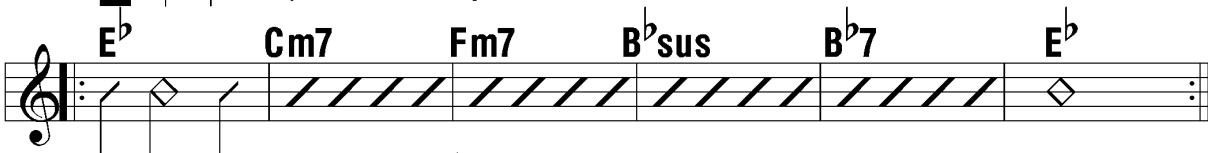
5. 

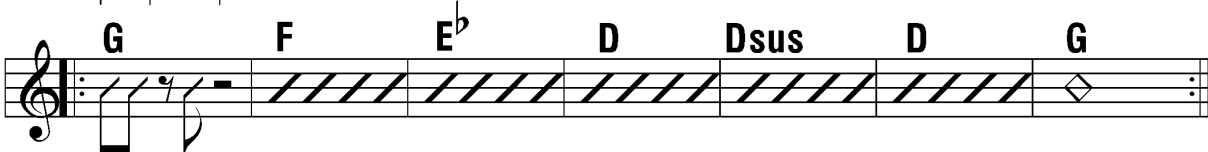
6. 

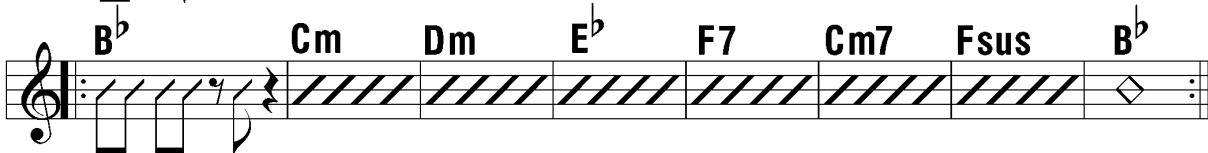
7. 

Keys & Key Signatures

KEY SIGNATURES are derived from the flats or sharps found in a major scale. Each major scale produces a unique combination of sharps or flats as its key signature. A key signature will never have both sharps and flats in it simultaneously. The order of the sharps and flats in a key signature come in a predictable sequence. The key signature order of sharps is F#, C#, G#, D#, A#, E#. The order of flats is Bb, Eb, Ab, Db, Gb, Cb.

Directions: Using your major scales, determine the proper key and list the key signature. Put sharps or flats in the proper order.

✓ Check your answers at www.LearnandMasterGuitar.com/answerkey

- | | |
|--|----------------------|
| 1) What key has 4 flats in its key signature? _____ | What are they? _____ |
| 2) What key has 3 sharps in its key signature? _____ | What are they? _____ |
| 3) What key has 2 flats in its key signature? _____ | What are they? _____ |
| 4) What key has 4 sharps in its key signature? _____ | What are they? _____ |
| 5) In the key of G, what note(s) are sharped/flatted? _____ | |
| 6) In the key of F, what note(s) are sharped/flatted? _____ | |
| 7) In the key of C, what note(s) are sharped/flatted? _____ | |
| 8) In the key of Db, what note(s) are sharped/flatted? _____ | |
| 9) In the key of B, what note(s) are sharped/flatted? _____ | |
| 10) What key has 2 sharps in its key signature? _____ | What are they? _____ |
| 11) What key has 5 sharps in its key signature? _____ | What are they? _____ |

Theory Tips & Tricks...How to determine a key by looking at the key signature.

For Keys with Sharps: The key is one half-step up from the last sharp in the key signature.

For example, if the key signature is F#, C#, G#, then the last sharp is G#. One half-step up from G# is A. The key is A.

For Keys with Flats: The key is the next to last flat in the key signature.

For example, if the key signature is Bb, Eb, Ab, the next to last flat is Eb. So, the key is Eb.

- 12) If the key signature has a Bb and an Eb in it, what's the key? _____
- 13) If the key signature has an F#, C#, G#, and a D#, what's the key? _____
- 14) If the key signature is F# and C#, what's the key? _____
- 15) If the key signature is Bb, Eb, Ab, and Db, what's the key? _____
- 16) If the key signature is F#, C#, G#, D#, A#, and E#, what's the key? _____

Relative Major and Minor Scales

There is a unique relationship between the keys of major scales and minor scales. This relationship is called RELATIVE. **Relative major and minor scales share the same key signatures.** To derive a relative minor scale: Go to the 6th step of the major scale and build an 8 note scale in that key. You can get to the 6th step of any major scale by either going up six steps from the root or down two steps. So, the C major scale and the A minor scale share the same key signature. Therefore A is the relative minor of C major and conversely C is the relative major of A minor.

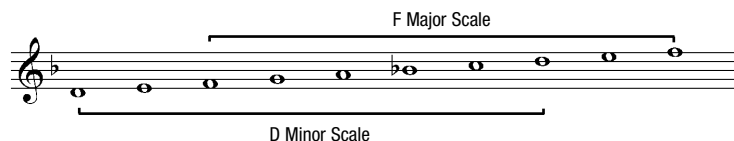
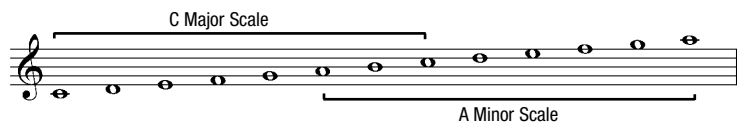
**Session 8 Assignment**

- Memorize the 5th String Barre Chord Forms. (page 48)
- Play through 5th String Barre Chord Exercises. Make sure each chord is sounding clear and that the chords change at the right time. (pages 48-49)
- Play Jamaica Farewell in F, both notes and chords. Use 6th and 5th string barre chords. (page 51)
- Play Jamaica Farewell in G, both notes and chords. Use 6th and 5th string barre chords. (page 51)
- Complete the Keys & Key Signatures Worksheet. (pages 49-50)

Jam Along CD #2
Track 23 - Slow Version
Track 24 - Medium Version
Track 25 - Fast Version

Jamaica Farewell

(in F)

Strumming Pattern

A diagram showing a strumming pattern on a guitar staff. The pattern consists of five strokes: a downstroke, a downstroke, an upstroke, an upstroke, and a downstroke. The notes indicated are G4, A4, Bb4, C5, and Bb4.

Musical notation for the first system of 'Jamaica Farewell' in F major. It consists of four staves of music. The first staff starts with a treble clef, a key signature of one flat (Bb), and a 4/4 time signature. The notes are: G4, A4, Bb4, C5, Bb4, A4, G4. The second staff continues: G4, A4, Bb4, C5, Bb4, A4, G4. The third staff continues: G4, A4, Bb4, C5, Bb4, A4, G4. The fourth staff continues: G4, A4, Bb4, C5, Bb4, A4, G4. Chord symbols are placed above the notes: F, Bb, C7, F, Bb, C7, F, Bb, C7, F, Bb, C, F.

Jam Along CD #2
Track 26 - Slow Version
Track 27 - Medium Version
Track 28 - Fast Version

Jamaica Farewell

(in G)

Strumming Pattern

A diagram showing a strumming pattern on a guitar staff. The pattern consists of five strokes: a downstroke, a downstroke, an upstroke, an upstroke, and a downstroke. The notes indicated are G4, A4, B4, C5, and B4.

Musical notation for the second system of 'Jamaica Farewell' in G major. It consists of four staves of music. The first staff starts with a treble clef, a key signature of one sharp (F#), and a 4/4 time signature. The notes are: G4, A4, B4, C5, B4, A4, G4. The second staff continues: G4, A4, B4, C5, B4, A4, G4. The third staff continues: G4, A4, B4, C5, B4, A4, G4. The fourth staff continues: G4, A4, B4, C5, B4, A4, G4. Chord symbols are placed above the notes: G, C, D7, G, C, D7, G, C, D7, G, C, D, G.

SESSION 9 - The Secret to Great Strumming



Estimated Time to Learn These Concepts - 2 Weeks

"Music produces a kind of pleasure which human nature cannot do without."
 ~ Confucius

Good Strumming Technique

- Hold your pick firmly.
- Keep your wrist loose.
- Strum the accurate number of strings on the down stroke but on the up stroke just hit a few of the strings.
- Strum smooth, even strums with no hesitations.

THE SECRET TO GREAT STRUMMING - KEEP YOUR HAND GOING!

Strumming with Eighth Notes

1.

2.

3.

Strumming with Eighth Notes & Ties

1.

2.

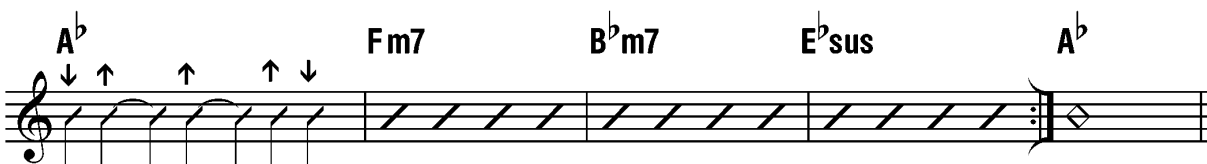
3. 

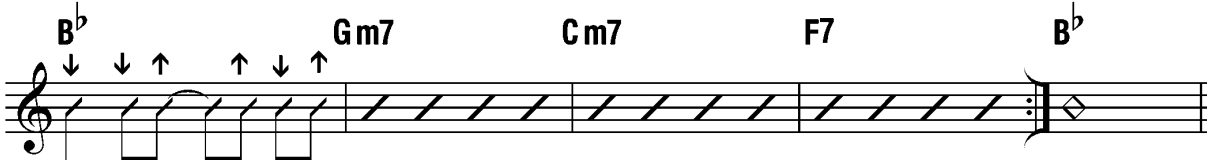
4. 

Diatonic Intervals

INTERVALS are the distance between two notes. DIATONIC refers to intervals that are found within the major scale. You will be given the key and a specific scale step and then you will need to derive the specific note. Here are some examples ...

- 1) In C, what is the 3rd step? The C scale is C - D - **E** - F - G - A - B - C. The 3rd step is E.
- 2) In A, what is the 6th? The A scale is A - B - C# - D - E - **F#** - G# - A. The 6th step is F#.

Diatonic Intervals Worksheet

Directions: Fill in the correct note corresponding to the diatonic interval asked for.

✓ Check your answers at www.LearnandMasterGuitar.com/answerkey

- | | | | |
|-----------------------------|-------------------|------------------------------|-------------------|
| 1) In C, what is the 4th ? | <u> F </u> | 11) In G, what is the 5th ? | <u> </u> |
| 2) In F, what is the 6th ? | <u> D </u> | 12) In D, what is the 7th ? | <u> </u> |
| 3) In Ab, what is the 4th ? | <u> </u> | 13) In A, what is the 3rd ? | <u> </u> |
| 4) The 4th in D is | <u> </u> | 14) The 6th in Gb is | <u> </u> |
| 5) The 6th in E is | <u> </u> | 15) The 7th in Db is | <u> </u> |
| 6) In D, what is the 6th ? | <u> </u> | 16) In Bb, what is the 6th ? | <u> </u> |
| 7) In G, what is the 7th ? | <u> </u> | 17) In F, what is the 7th ? | <u> </u> |
| 8) In Db, what is the 2nd ? | <u> </u> | 18) The 2nd in B is | <u> </u> |
| 9) The 2nd in F# is | <u> </u> | 19) The 3rd in F# is | <u> </u> |
| 10) The 3rd in D is | <u> </u> | 20) The 3rd in Gb is | <u> </u> |

Harmonic Intervals

HARMONIC INTERVALS are intervals that have been raised or lowered a half step from their natural major scale (diatonic) position.

The intervals within a major scale are divided into two groups; MAJOR and PERFECT. The 2nd, 3rd, 6th, and 7th are referred to as MAJOR INTERVALS. The 4th, 5th, and octave are referred to as PERFECT INTERVALS.

MAJOR INTERVALS

2nd 3rd 6th 7th

Lowered a 1/2 step - **MINOR**
(flatted)

Raised a 1/2 step - **AUGMENTED**
(sharped)

PERFECT INTERVALS

4th 5th Octave

Lowered a 1/2 step - **DIMINISHED**
(flatted)

Raised a 1/2 step - **AUGMENTED**
(sharped)

For MAJOR INTERVALS - If a major interval (2nd, 3rd, 6th & 7th) is lowered by a half step it is called MINOR. If a major interval is raised a half step it is called AUGMENTED.

For PERFECT INTERVALS - If a perfect interval (4th, 5th & Octave) is lowered a half step it is called DIMINISHED. If it is raised a half step then it is also called AUGMENTED.

ENHARMONIC notes are two notes that have the same pitch but two different names.

Double Sharps and Double Flats

If I need to lower an already flatted note, I just add another flat until I get to the pitch I need. For example, if you were asked to find the minor 3rd in Gb, you would solve the problem as follows. The 3rd in the key of Gb is a Bb. So to make it minor we would need to lower the Bb an additional half step making it a Bbb. So the correct answer would be Bbb or B “double flat.”

Here is another example. If you were asked to determine the augmented 2nd in E, the problem would be solved this way. In the key of E the second is an F#. So to augment it I would need to raise it up an additional half step making it an F## or F “double sharp.”

Remember to not answer the enharmonic equivalent of the note. In our previous example, an F## would also be a G. But a G would be the wrong answer to this problem because in the key of E a G would be a minor 3rd not an augmented 2nd.

Harmonic Intervals Worksheet

Directions: Fill in the correct note corresponding to the harmonic interval asked for. Add double sharps or flats if needed.

✓ Check your answers at www.LearnandMasterGuitar.com/answerkey

- | | | | |
|--|-----------|------------------------------|-------|
| 1) In C, what is the minor 6th ? | <u>Ab</u> | 6) The minor 2nd in D is | _____ |
| 2) In F, what is the augmented 2nd ? | <u>G#</u> | 7) The augmented 6th in E is | _____ |
| 3) In Bb, what is the diminished 5th ? | _____ | 8) The minor 7th in B is | _____ |
| 4) In Eb, what is the minor 3rd ? | _____ | 9) The minor 6th of F# is | _____ |
| 5) In Ab, what is the diminished 5th ? | _____ | 10) The minor 7th of G is | _____ |

Session 9 Assignment

- Practice all of the Strumming Examples given. Start slowly, then gradually increase your speed. Remember to use good technique and to always keep your strumming hand going. (pages 52-53)
- Play La Bamba, both notes and chords, using the strumming pattern given. (page 55)
- Play The Wabash Cannonball, both notes and chords, with the strumming pattern. (page 56)
- Play Blues in E, both notes and chords, with the strumming pattern. (page 56)
- Complete the Interval Worksheets. (pages 53, 55)

 **Jam Along CD #3**
Track 2 - Slow Version
Track 3 - Medium Version
Track 4 - Fast Version

La Bamba

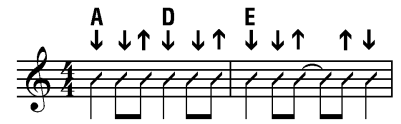

Strumming Pattern



Jam Along CD #3
Track 5 - Slow Version
Track 6 - Medium Version
Track 7 - Fast Version

The Wabash Cannonball

Strumming Pattern

G **G7** **C**

Lis - ten to the jin - gle, the rum - ble and the roar.

D7 **G**

Rid - ing through the wood - lands to the hills and by the shore. Hear the

G7 **C**

might - y rush of en - gine, hear the lone - some ho - bo squall.

D7 **G**

Rid - ing through the jun - gle on the Wa - bash Can - non ball.

Jam Along CD #3
Track 8 - Slow Version
Track 9 - Medium Version
Track 10 - Fast Version

Blues in E

Strumming Pattern

E7

A7 **E7**

B7 **A7** **E7** **B7** **E**

SESSION 10 - Fingerstyle Guitar

 Estimated Time to Learn These Concepts - 3 Weeks

"One must make of one's fingers well drilled soldiers."
 ~ Fernando Sor, Classical Guitarist & Composer (1778-1838)

Keys to Good Fingerstyle Technique

- Have a relaxed fingering hand.
- Bring your thumb slightly forward.
- Make sure each finger has freedom of movement.
- Go SLOW. Speed will come as you gain control.

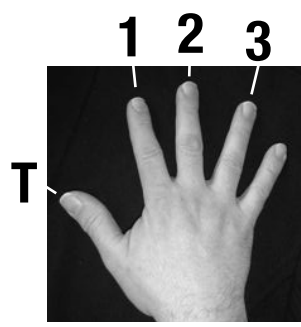

Fingerstyle Technique Exercises: Finger Pattern 1

Finger Pattern 1
Thumb - 1st - 2nd - 3rd

Directions: Play each exercise slowly in an even, steady rhythm using finger pattern 1. Slowly increase your speed only after you have control of your fingers.

1.

2.

3.

G C

4.

D G D A

Fingerstyle Technique Exercises: Finger Pattern 2

Finger Pattern 2
Thumb - 3rd - 2nd - 1st

1.

G C

2.

D G D A

Fingerstyle Technique Exercises: Finger Pattern 3

Finger Pattern 3
Thumb - 2nd - 1st - 3rd

1.

2.

Merle Travis Fingerstyle Technique

1.

2.

Chord diagrams for C and F are shown above the first system. The first system consists of a treble clef staff in 4/4 time, a tablature staff with strings T, A, and B, and a bass clef staff. The second system features a G7 chord diagram (3 fret) and a C chord diagram above the treble staff. The tablature continues with string T, A, and B.

Giuliani Studies for Classical Guitar

Mauro Giuliani (1781-1828)

1.

Chord diagrams for C and G7 are shown above the first system. The first system consists of a treble clef staff in 4/4 time, a tablature staff with strings T, A, and B, and a bass clef staff. The second system features a C chord diagram and a G7 chord diagram above the treble staff. The tablature continues with string T, A, and B.

Session 10 Assignment

- Practice all of the Fingerstyle Exercises. Start slowly to gain control, then gradually increase your speed. (pages 57-59)
- Practice the Merle Travis and Giuliani Finger Style Exercises. (pages 59-60)
- Play House of the Rising Sun with fingerstyle accompaniment pattern. (page 61)
- Play Canon in D. Do one section at a time. It is a great song and worth the extra effort. (page 62)

Jam Along CD #3
Track 11 - Slow Version
Track 12 - Medium Version
Track 13 - Fast Version

House of the Rising Sun

Am C D F Am C E

Melody

Finger Style Accompaniment

Am C D F Am E Am

Jam Along CD #3
Track 14 - Slow Version
Track 15 - Medium Version
Track 16 - Fast Version

Canon in D

(Pachelbel's Canon)
 Johann Pachelbel
 (1653-1706)

D A Bm F#m G D/F# G A

TAB: 0 2 3 2 | 2 2 2 2 | 2 4 4 3 | 4 2 2 2 | 0 0 0 2 3 | 0 0 0 2 2 2 | 3 0 0 2 2 2

D A Bm F#m G D/F# G A

TAB: 2 3 0 2 2 | 2 2 2 2 | 3 4 2 2 | 2 2 2 2 | 0 0 3 2 0 | 0 0 0 2 0 | 0 0 0 2 2 2

D A Bm F#m G D/F# G A

TAB: 5 2 3 5 2 3 5 | 2 3 5 2 3 | 2 3 5 2 | 3 5 2 | 0 3 2 0 | 2 0 2 0 0 2 | 0 2 3 | 0 3 2 3 2 3 2 3 | 3 0 2 3 5

D A Bm F#m G D/F# G A D

TAB: 5 3 5 7 5 3 | 2 2 3 2 0 | 3 3 3 2 0 | 3 1 0 2 2 2 2 | 2 3 2 2 2 2 | 0 2 2 2 2 2 | 2 2 2 2 2 2

SESSION 11 - Pentatonic Scales - The Foundation of Soloing



Estimated Time to Learn These Concepts - 4 Weeks

"Our musical minds know everything they have ever heard, while our hands know only what we've trained them to do."

~ Chris Proctor, *Fingerstyle Guitarist*

What's a Pentatonic Scale?

A PENTATONIC SCALE is a five note scale derived from the major scale. It uses the first, second, third, fifth, and sixth steps of the major scale.

C Major Scale

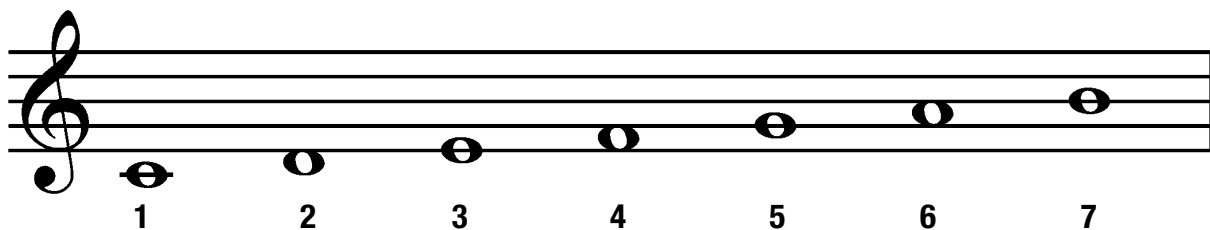

C Pentatonic Scale

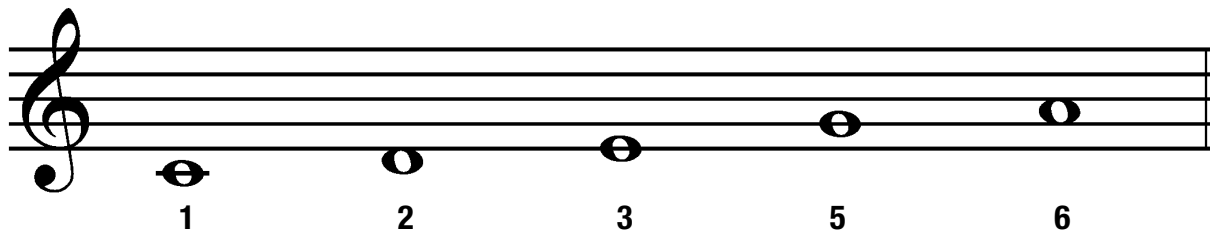

Relative Major & Minor Roots

There is a special relationship between the first and sixth step of the major scale which is called RELATIVE. The first step of the major scale is called the RELATIVE MAJOR. The sixth step is called the RELATIVE MINOR. To find the relative minor when given the relative major you would go up from the relative major six steps in the major scale. You could also go down two steps from the relative major to find the relative minor. After you find the relative major or minor root, you can then build the appropriate major or minor scale. Relative major and minor scales share the same KEY SIGNATURE.

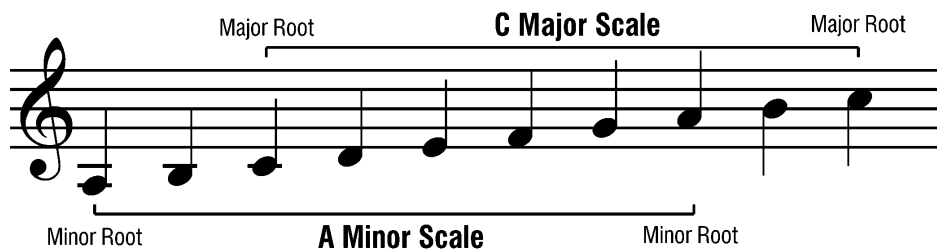

The Five Pentatonic Forms

Since there are five notes in a pentatonic scale, there are five different forms that we can use to play the scale if we start on each different note. These are the five forms of a C major pentatonic scale or an A minor pentatonic scale. The diamond shows the major root and the open circle shows the minor root. On guitar, these five forms connect together like overlapping puzzle pieces as shown in the lower example.

◇ = Major Root ○ = Minor Root

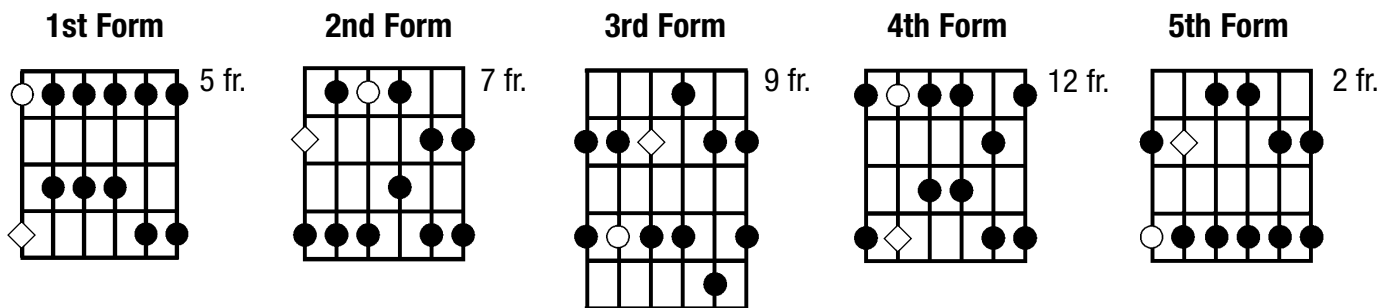

Pentatonic Forms Connect Together

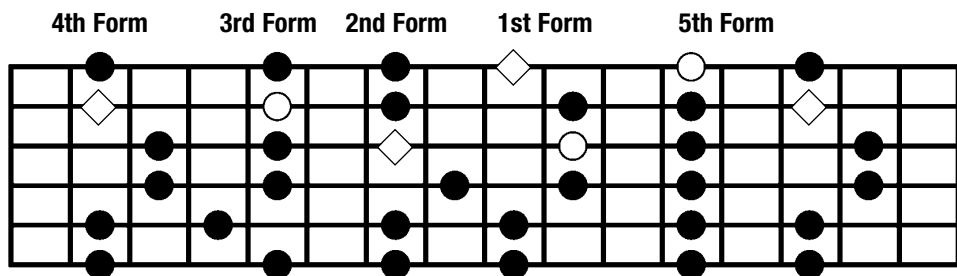

Common Pentatonic Patterns

Directions: These examples are given in pentatonic form #1. Practice each pattern. Begin slowly, then gradually increase speed. Try playing these patterns in different keys and places on the neck. Use all pentatonic forms.

Pattern #1 (Sets of 4)

Ascending

Descending

Pattern #2 (Sets of 3)

Ascending and Descending

Musical notation for Pattern #2 (Sets of 3) showing ascending and descending scales with guitar tablature. The notation includes a treble clef, a key signature of one flat, and a 4/4 time signature. The ascending scale is shown in the first staff, and the descending scale is shown in the second staff. The guitar tablature is provided below the musical notation, with fret numbers indicated by numbers on the lines.

Pattern #3 (3 Pairs)

Ascending

Musical notation for Pattern #3 (3 Pairs) showing ascending scales with guitar tablature. The notation includes a treble clef, a key signature of one flat, and a 4/4 time signature. The ascending scale is shown in the first staff, and the guitar tablature is provided below the musical notation, with fret numbers indicated by numbers on the lines.

Descending

Musical notation for Pattern #3 (3 Pairs) showing descending scales with guitar tablature. The notation includes a treble clef, a key signature of one flat, and a 4/4 time signature. The descending scale is shown in the first staff, and the guitar tablature is provided below the musical notation, with fret numbers indicated by numbers on the lines.

Session 11 Assignment

- Practice all of the pentatonic forms ascending and descending. Memorize them. (page 64)
- Practice the pentatonic forms in all of the keys. (page 64)
- Practice connecting them together to play in all the keys the full length of the guitar. (page 64)
- Practice the common pentatonic patterns in various keys and places on the neck. (pages 64-65)
- Practice soloing using pentatonic scales on A Minor Pentatonic Blues, G Major Pentatonic, and Around the Pentatonic World. Make up your own solo using the scales suggested. (page 66)

 Jam Along CD #3
Track 17

A Minor Pentatonic Blues

Solo using the A Minor Pentatonic Scale

Slow Blues

 Jam Along CD #3
Track 18

G Major Pentatonic

Solo using a G Major Pentatonic Scale

Medium Groove

 Jam Along CD #3
Track 19

Around the Pentatonic World

Solo using the appropriate Pentatonic Scale

Medium Latin

SESSION 12 - Advanced Chords



Estimated Time to Learn These Concepts - 2 Weeks

"It's important to other musicians, but on records, fast picking doesn't mean a thing. People want to hear melody and nice harmony."

~ Chet Atkins

Open Two Chords

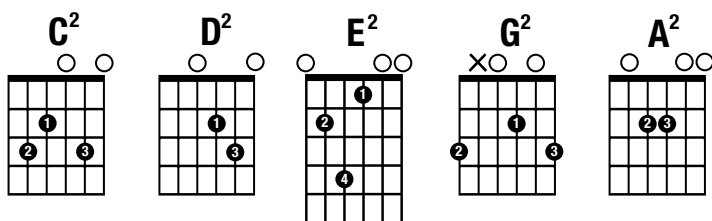

Moveable Two Chords

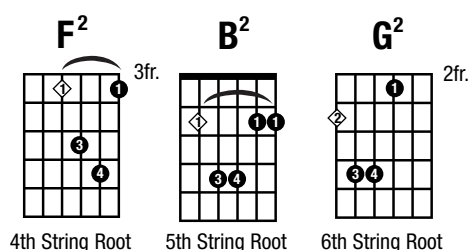

Open Major 7th Chords

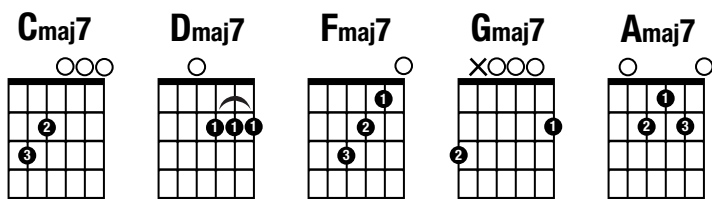

Moveable Major 7th Chords

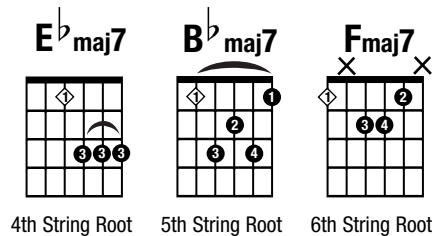

Open Minor 11th Chords

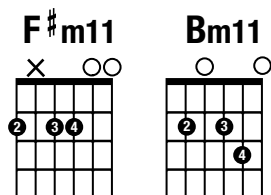

Moveable Minor 11ths

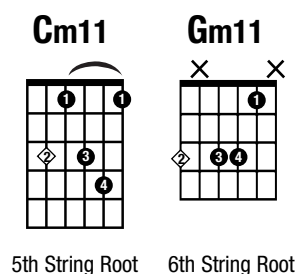

Two Chord Exercises

1. **C2** **Am7** **D2** **G2** **C**
E2 **A2** **E2** **A2** **E2**

2. **F2** **Gm7** **B^b2** **Csus** **C7** **F2**
3fr. 3fr. 3fr. 3fr. 3fr. 3fr.

Major 7th Exercises

1. **Cmaj7** **Dm7** **Fmaj7** **Am7** **Gsus** **Cmaj7**
3fr.

2. **Dmaj7** **Em7** **Asus** **Gmaj7** **Asus** **Dmaj7**

Minor 11th Exercises

1. **E2** **F#m11** **A2** **Bm11** **E7** **Amaj7**

2. **Gm11** **D7** **Gm11** **Dsus** **Gm11**

Theory Tips & Tricks...Substituting Chords.

For Major Chords: To spice up any MAJOR chord, you can substitute a TWO chord.

For example, if the chord progression is a C to an F chord, then play a C2 to an F2.

For Minor Chords: To spice up any MINOR chord, you can substitute a MINOR 11TH chord.

For example, if the chord progression includes a Dm, then play a Dm11 in it's place.

Chord Substitution Examples

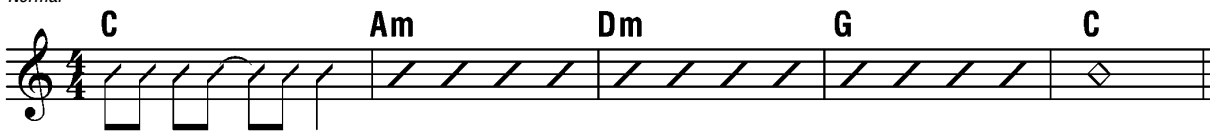
1. *Normal*

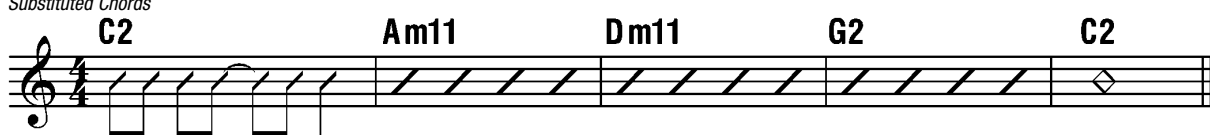
Substituted Chords

2. *Normal*

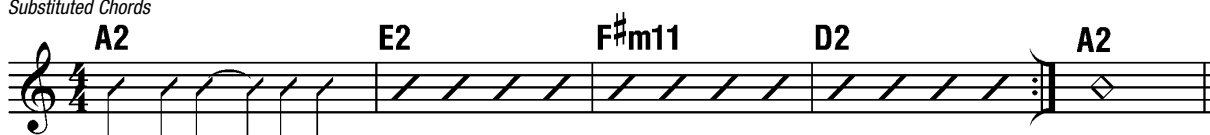
Substituted Chords

Session 12 Assignment

- Practice all of the advanced chord forms. Memorize them. (page 67)
- Play the Two Chord, Major 7th, Minor 11th and Chord Substitution Exercises. (pages 68-69)
- Play Rockin', Suspended Smooth, and Acoustic Groove with the Jam Along CD. (page 70)

Jam Along CD #3
Track 20

Rockin'

Medium Rock

Musical notation for 'Rockin' in G major, 4/4 time. The piece consists of three staves. The first staff is the melody, the second is the guitar accompaniment, and the third is the bass line. The melody starts with a D chord and follows the notes D4, A4, B4, G4, A4, D4, A4, B4, G4, A4. The guitar accompaniment features a C2 chord in the first two measures and a G2 chord in the last two measures. The bass line starts with a C2 chord, moves to an Asus chord in the second measure, then an A chord in the third measure, and ends with a D chord in the fourth measure.

Jam Along CD #3
Track 21

Suspended Smooth

Slow

Musical notation for 'Suspended Smooth' in G major, 4/4 time. The piece consists of four staves. The first staff is the melody, the second is the guitar accompaniment, the third is the bass line, and the fourth is the bass line. The melody starts with a Dsus chord and follows the notes D4, A4, B4, G4, A4, D4, G2. The guitar accompaniment features a Dsus chord in the first two measures, an Asus chord in the third measure, and a G2 chord in the fourth measure. The bass line starts with a B^bmaj7 chord in the first two measures, a C2 chord in the third measure, and a D2 chord in the fourth measure.

Jam Along CD #3
Track 22

Acoustic Groove

Medium Acoustic

Musical notation for 'Acoustic Groove' in G major, 4/4 time. The piece consists of three staves. The first staff is the melody, the second is the guitar accompaniment, and the third is the bass line. The melody starts with an E2 chord and follows the notes E2, F#2, A2, B2, A2, G2, F#2, E2. The guitar accompaniment features a Bm11 chord in the first two measures, an Esus chord in the third measure, and a Dmaj7 chord in the fourth measure. The bass line starts with a Bm11 chord in the first two measures, an Esus chord in the third measure, and a B chord in the fourth measure.

SESSION 13 - Playing the Blues



Estimated Time to Learn These Concepts - 2 Weeks

"We all have idols. Play like anyone you care about but try to be yourself while doing so."

~ B.B. King, *Legendary Blues Guitarist*

What's a Blues Scale?

A BLUES SCALE is derived from the major scale. Some notes are added and some notes are adjusted. To form a blues scale, you add the flatted third and the flatted fifth. Also, adjust the seventh step of the major scale down a half step to form a flatted seventh. The flatted third, fifth, and seventh would be called the BLUES NOTES.

C Major Scale

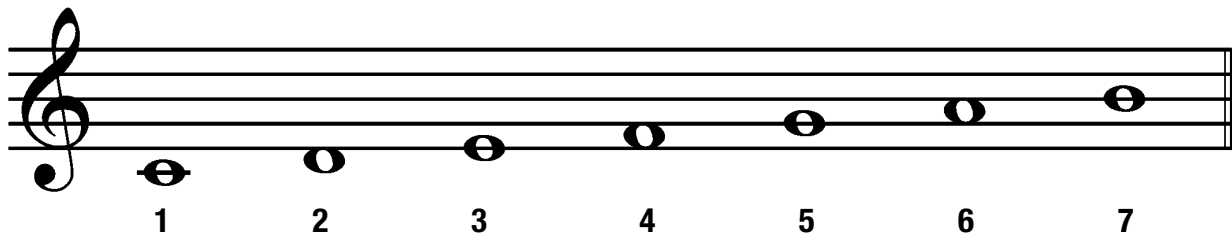

C Blues Scale

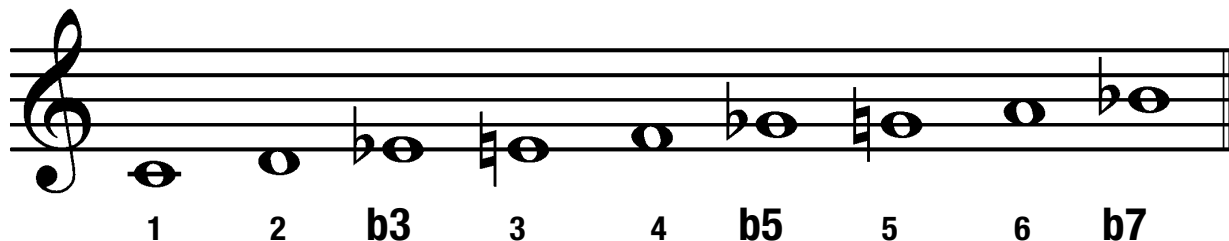

C Minor Pentatonic Scale

The C MINOR PENTATONIC scale already includes all but one of the blues notes. So, an easy way to sound bluesy is to play the minor pentatonic form. If you wanted to add the flatted fifth blues note, you would need to add one extra note to the form.

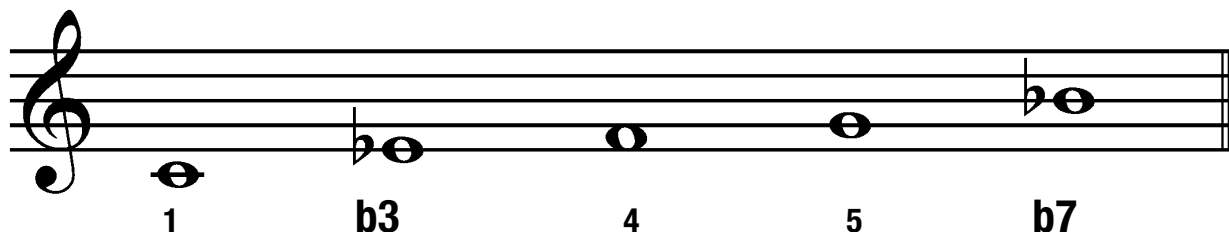

C Minor Pentatonic With Added Flatted 5th

If you wanted to add the flatted fifth blues note, you would just need to add one extra note to the minor pentatonic form.

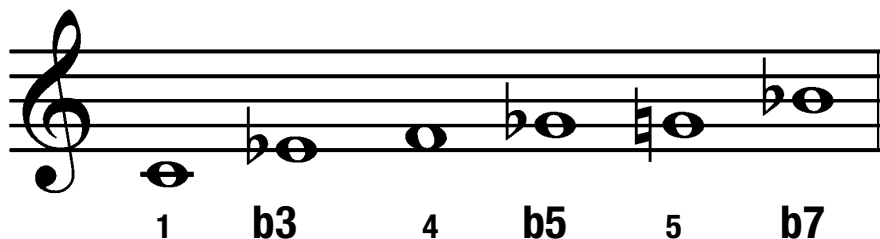

Pentatonic 1st Form with added blues note

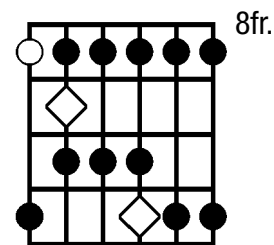

◇ = Added Blues Note

Pentatonic Forms with Blues Notes

Based on an A minor pentatonic.

○ = Minor Root ◇ = Blues Note

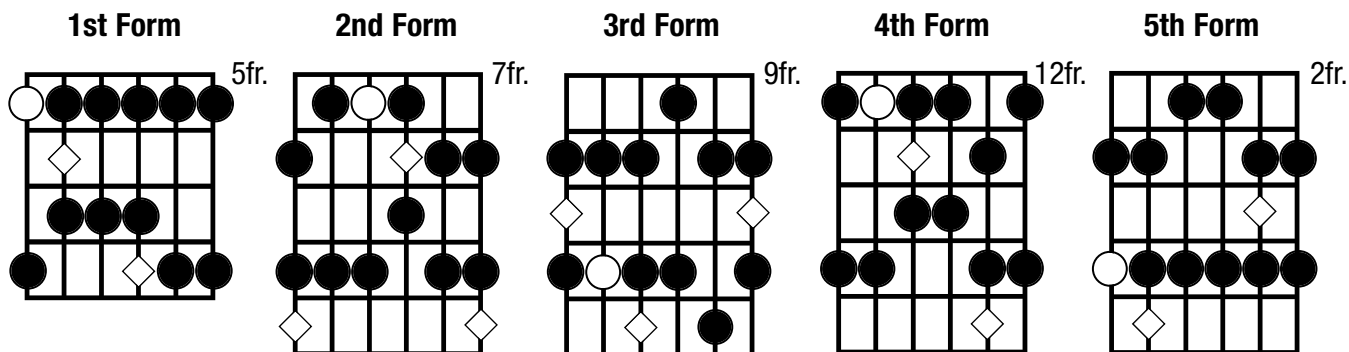

The Blues Chord Progression

The BLUES CHORD PROGRESSION consists of 12 measures which have a specific pattern of chords in the key. These chords are represented by Roman numerals.

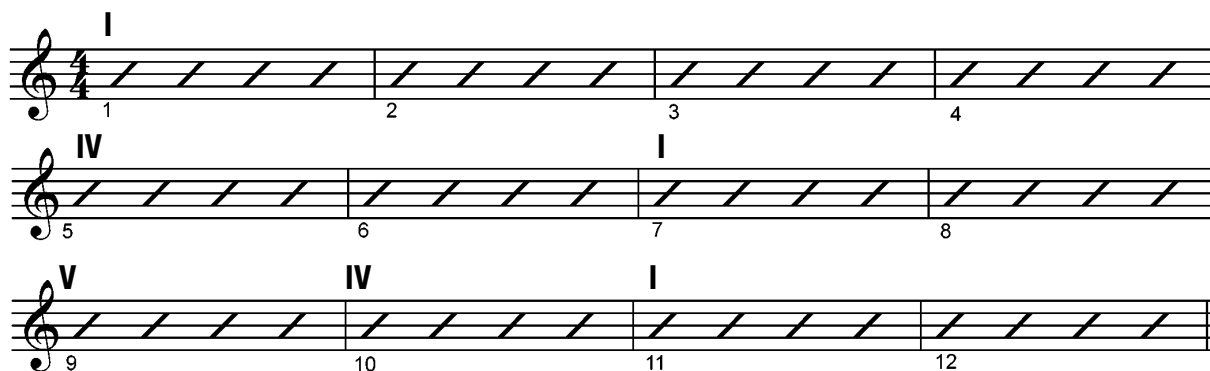

Blues Progression in C or C Blues

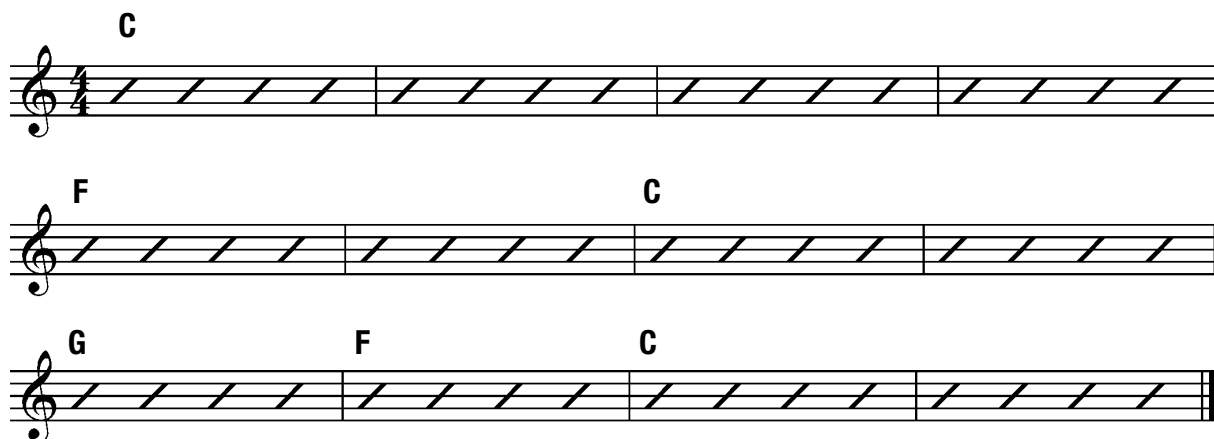

Triads

A TRIAD is a combination of three notes played together. A triad is made up of the FIRST, THIRD, and FIFTH notes of the major scale.

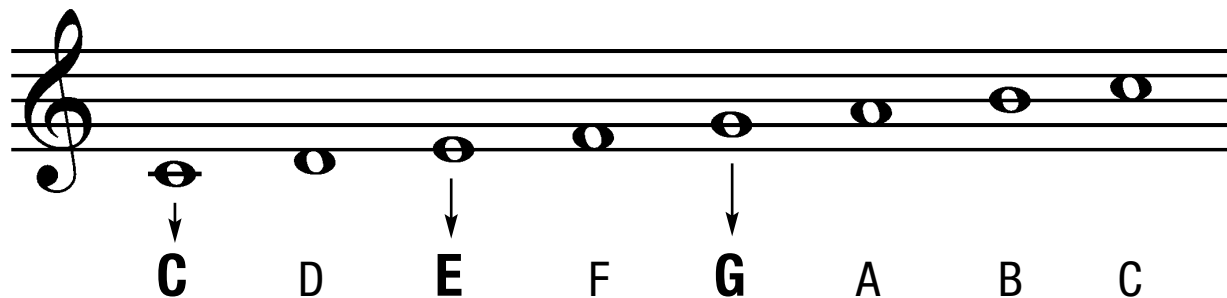

These scale tones are adjusted up or down according to a formula to form the different types of triads. The four main types of triads are MAJOR, MINOR, AUGMENTED, and DIMINISHED. The chart below shows each triad type and the corresponding formula.

<u>Triad Types</u>	<u>Scale Tone Formulas</u>
Major	1 - 3 - 5
Minor	1 - b3 - 5
Augmented	1 - 3 - #5
Diminished	1 - b3 - b5

Triad Examples in C

- 1) A **C Major** triad would use the 1st, 3rd and 5th scale tones from the C major scale. So, a C Major triad would be C, E and G.
- 2) A **C Minor** triad would use the same scale tones, but we would need to lower the 3rd a half step. So, a C Minor triad would be C, **Eb**, and G.
- 3) A **C Augmented** triad would require us to raise the 5th step up a half step. So, a C Augmented triad would be C, E, and **G#**.
- 4) A **C Diminished** triad would have us lower the 3rd and the 5th scale tone down a half step. This would make a C Diminished triad be C, **Eb**, and **Gb**.

Triad Worksheet

Directions: Fill in the proper letter names for each triad.

✓ Check your answers at www.LearnandMasterGuitar.com/answerkey

- | | | | | | | | |
|-----------------|---------------|---------------|---------------|-------------------|---------------|---------------|---------------|
| 1) F Minor | <u> F </u> | <u> Ab </u> | <u> C </u> | 11) F Major | <u> </u> | <u> </u> | <u> </u> |
| 2) G Major | <u> G </u> | <u> B </u> | <u> D </u> | 12) G Minor | <u> </u> | <u> </u> | <u> </u> |
| 3) C Diminished | <u> </u> | <u> </u> | <u> </u> | 13) Bb Diminished | <u> </u> | <u> </u> | <u> </u> |
| 4) Bb Augmented | <u> </u> | <u> </u> | <u> </u> | 14) D Augmented | <u> </u> | <u> </u> | <u> </u> |
| 5) Eb Major | <u> </u> | <u> </u> | <u> </u> | 15) Eb Minor | <u> </u> | <u> </u> | <u> </u> |
| 6) D Minor | <u> </u> | <u> </u> | <u> </u> | 16) A Major | <u> </u> | <u> </u> | <u> </u> |
| 7) A Diminished | <u> </u> | <u> </u> | <u> </u> | 17) Ab Minor | <u> </u> | <u> </u> | <u> </u> |
| 8) Ab Major | <u> </u> | <u> </u> | <u> </u> | 18) E Augmented | <u> </u> | <u> </u> | <u> </u> |
| 9) E Minor | <u> </u> | <u> </u> | <u> </u> | 19) Db Major | <u> </u> | <u> </u> | <u> </u> |
| 10) C Minor | <u> </u> | <u> </u> | <u> </u> | 20) B Minor | <u> </u> | <u> </u> | <u> </u> |

Session 13 Assignment

- Practice all of the Pentatonic Forms with Blues Notes in all keys for the full range of the guitar. (page 72)
- Memorize the Blues Chord Progression. (pages 72-73)
- Memorize the four Triad Types and complete the Triad Practice Worksheet. (pages 73-74)
- Play Jammin the Blues and Johnny's E Blues with the Jam Along CD. Practice playing the chords and soloing using the pentatonic forms with blues notes. (page 75)

Jam Along CD #4
Track 2 - Slow Version
Track 3 - Fast Version

Jammin the Blues

Solo using the C minor pentatonic scale with the added blues note.

Swing Jazz

Musical notation for 'Jammin the Blues' in 4/4 time. The piece is in C7, F7, and G7. The notation consists of three staves. The first staff starts with a C7 chord and contains a melodic line. The second staff starts with an F7 chord and contains a melodic line. The third staff starts with a G7 chord and contains a melodic line. The piece ends with a double bar line and a repeat sign.

Jam Along CD #4
Track 4 - Slow Version
Track 5 - Fast Version

Johnny's E Blues

Solo using the E minor pentatonic scale with the added blues note.

Musical notation for 'Johnny's E Blues' in 4/4 time. The piece is in E7, A7, and B7. The notation consists of four staves. The first staff starts with an E7 chord and contains a melodic line. The second staff starts with an A7 chord and contains a melodic line. The third staff starts with an E7 chord and contains a melodic line. The fourth staff starts with an A7 chord and contains a melodic line. The piece ends with a double bar line and a repeat sign.

SESSION 14 - Giving Your Playing Some Style



Estimated Time to Learn These Concepts - 1 Week

How many guitar players does it take to change a light bulb? Five. One to change it and the other four to say "I could do that."

Sliding to Notes

SLIDING involves approaching a note from above or beneath, usually from a half step or whole step.

1.

2.

Sliding Riff

In C, on 5th String

In F, on 6th String

Bends

BENDS involve playing a note and then bending the string, either a half or whole step, to another pitch. Always bend to a specific pitch. Normally, you would use your third or fourth finger (pinky) to bend with the other fingers helping.

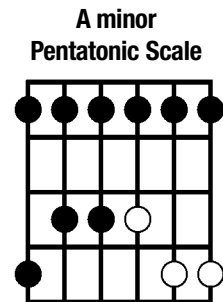

○ = Notes that are good to bend.

Major Scale Bending Exercise

Hammer-ons

A HAMMER-ON is a technique with which you pick the first note, then by hitting your fretting finger hard on the fretboard you get the second note to sound without picking it.

Pull-offs

A PULL-OFF is a technique where you pick the first note then pull off your fretting finger so that the remaining fretted note sounds without picking it.

Tapping

TAPPING is a technique combining hammer-ons and pull-offs. It also incorporates reaching over with your picking hand to hammer on a note on the fretboard.

Major Scale in Harmonics Example

(Barre at 3rd Fret)

Session 14 Assignment

- Practice the Major Scale Bending Exercise. Bend accurately to the correct pitch. (page 77)
- Practice the Sliding Riff on the fifth and sixth string. Do it in various keys. (page 76)
- Practice Palm Muting on the pentatonic scales. Go for a consistent, good muted string tone.
- Practice the Jazz Octaves technique.
- Play Bending the Blues, Jazz Octaves, and The Funky Mute with the Jam Along CD. (pages 78-79)

 Jam Along CD #4
Track 6

Bending the Blues

Solo using the A minor pentatonic scale bending the correct notes.

Slow Blues

 Jam Along CD #4
Track 7

Jazz Octaves

Play the melody using jazz octaves then solo in the key of Bb.

Swing Feel

 Jam Along CD #4
Track 8

The Funky Mute

Use palm muting starting at the 5th position.

Medium Funk

SESSION 15 - Electric Guitars - The Heart of Rock & Roll



Estimated Time to Learn These Concepts - 1 Week

"We don't like their sound, and guitar music is on the way out."
 ~ Decca Recording Company rejecting the Beatles 1962

Power Chords

POWER CHORDS are chords that only use the root and 5th steps of the major scale. The chord symbol is abbreviated to the root and the number 5 (ie. C5, F5). They are played using two or three strings. The examples shown include three strings. To play the two string version, just omit the highest pitch played with your fourth finger.

Moveable Power Chords

Open Power Chords

F5		B5		E5	A5	G5	D5
XXX	X	XX		O	XXX	XO	XX
XO						XOO	XXO
X							X

6th String Form 5th String Form

Power Chord Exercises

1.

C5 **B^b5** **F5**

3fr.

TAB: 5 5 5 5 5 5 | 3 3 3 3 3 3 | 3 3 3 3 3 3 | 3 3 3 3 3 3

B: 3 3 3 3 3 3 | 1 1 1 1 1 1 | 1 1 1 1 1 1 | 1 1 1 1 1 1

2.

G5 **C5** **D5** **C5** **G5**

TAB: 5 5 5 | 5 5 | 7 7 7 | 5 5 | 5 5

B: 3 3 3 | 3 3 | 5 5 5 | 3 3 | 3

In a quick 4

3.

Chord symbols: E5, D5, A5, E5

4.

Chord symbols: F5, G5, F5 G5, F5 G5, F5 G5, F5 G5, F5 G5, F5 G5

Country Chicken Pickin' Exercises

Entire Phrase in A

Techniques: B, H

Techniques: H, H, P, P

In E

In D

Country Bends Example

In G ^{8va} This means to play an octave higher than written.

Country Arpeggio Example

In A

Sliding Fourths Example

SLIDING FOURTHS are built off of the root or the fifth with the two notes used being the root or the fifth and the fourth below.

In A

The Harmonized Major Scale

A HARMONIZED MAJOR SCALE is a specific pattern of chords that are derived from the major scale. A triad is built on each note of the major scale. In the key, start on 1-3-5 and then move up a scale step for each note (ie... 2-4-6 3-5-7 4-6-8 and so on). These combinations of notes form triads in the same predictable pattern for every key. The triads built on the first, fourth, and fifth scale steps end up becoming MAJOR CHORDS. The triads built on the second, third, and sixth scale steps become MINOR CHORDS. The triad built on the seventh scale step is a DIMINISHED CHORD. This pattern of chords is consistent in every key.

MAJOR CHORDS

1st, 4th, 5th
I, IV, V

In any key, triads built off of the 1st, 4th, and 5th scale steps become **MAJOR CHORDS**.

MINOR CHORDS

2nd, 3rd, 6th
ii, iii, vi

In any key, triads built off of the 2nd, 3rd, and 6th scale steps become **MINOR CHORDS**.

DIMINISHED CHORD

7th
vii diminished

In any key, a triad built off of the 7th scale step becomes a **DIMINISHED CHORD**.

Session 15 Assignment

- Practice Power Chords and Power Chord Exercises. Change chords accurately and quickly. (pages 80-81)
- Practice Chicken Pickin' Exercises and make up some on your own. (pages 81-82)
- Practice the Sliding 4ths Exercise. Practice moving to various keys. (page 83)
- Play Power Chord Rock and Power Riffs with the Jam Along CD. (page 84)

Jam Along CD #4
Track 9

Power Chord Rock

Solo in the key of G.

Up Tempo Rock

G5 D5 Em C5 G5

T
A
B

G5 D5 Em C5

T
A
B

C5 D5 C5 D5

T
A
B

Jam Along CD #4
Track 10

Power Riffs

Play the power chord melody then solo on E minor pentatonic.

Medium Heavy Rock

E5 D5 E5 E5 D5 C5 D5

E5 D5 E5 E5 D5 C5 D5

G5 F5 C5

SESSION 16 - Advanced Strumming - Going Beyond the Basics



Estimated Time to Learn These Concepts - 2 Week

"A good instrument is really an inspiration. When you have a truly fine instrument, suddenly even the most simple things sound good."

~ Mason Williams - *Guitarist on the song "Classical Gas"*

Sixteenth Notes

SIXTEENTH NOTES are the smallest subdivision of notes that you are likely to see as a guitar player. There are FOUR sixteenth notes for every beat.

1.

2.

3.

Sixteenth Note Strumming Exercises

1.

2.

3.

4.

Strumming with Accents Exercises

1.

2.

3.

4.

5.

6.

This is the same rhythm as #5 with only the accented notes played.

7.

8.

Repeat the same rhythm.

Strumming Exercises

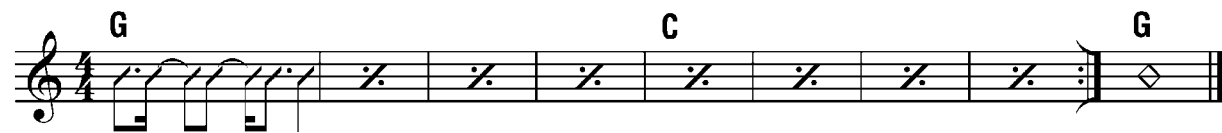
1. 

2. 

3. 

Session 16 Assignment

- Practice all sixteenth note strumming exercises with open and barre chords. Start slowly then gradually increase speed. (pages 85-87)
- Experiment with making up your own strumming patterns.
- Play Rolling Along, A Little Bit Rocky, and Electric Funk with the Jam Along CD. (pages 87-88)

 Jam Along CD #4
Track 11

Rolling Along

Relaxed Acoustic Feel

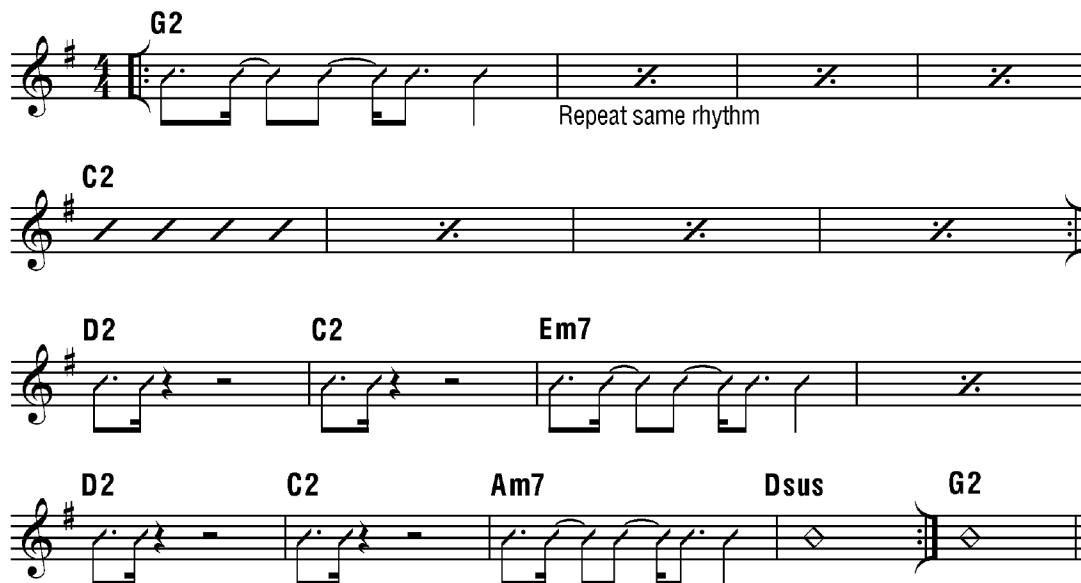

Repeat same rhythm

Jam Along CD #4
Track 12

A Little Bit Rocky

Aggressive Acoustic

A G D Dsus D A G D Dsus D

A G Bm A Bm G A D Dsus D

Bm G5 Bm G2 A D5

Jam Along CD #4
Track 13

Electric Funk

Medium Funk Groove

G5 F2 G5 F2

G5 F2 G5

SESSION 17- Going Beyond the First Position



Estimated Time to Learn These Concepts - 4 Weeks or more

"Playing scales is like a boxer skipping rope or punching a bag. It's not the thing in itself, it's preparatory to the activity."
 ~ Barney Kessel, Jazz Guitarist

Three Note on a String Scales

THREE NOTE ON A STRING SCALES are a way of playing major scales on a guitar that help you learn the notes on the entire neck of your guitar and also help you with developing speed, triplet technique, and soloing.

F Major Scale

<p>1st Form</p>	<p>3fr.</p>
<p>2nd Form</p>	<p>5fr.</p>
<p>3rd Form</p>	<p>6fr.</p>
<p>4th Form</p>	<p>8fr.</p>
<p>5th Form</p>	<p>10fr.</p>
<p>6th Form</p>	<p>12fr.</p>

Seventh Chords

A SEVENTH CHORD is a combination of FOUR notes played together.

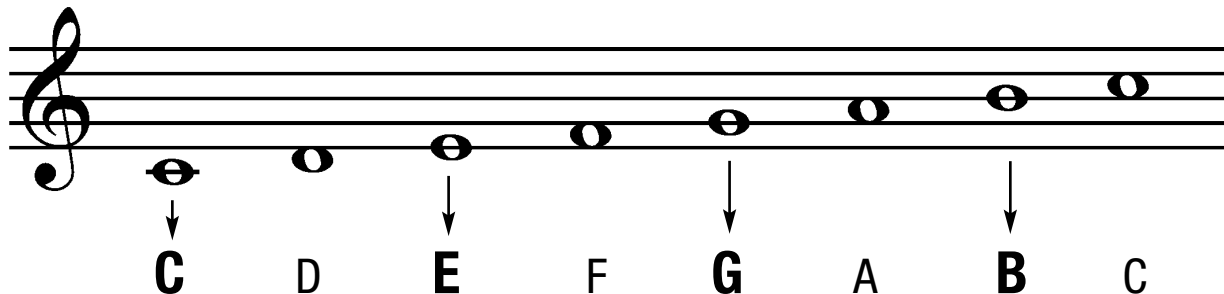

There are SIX common types of seventh chords. With the addition of the seventh scale step, the number of ways all these tones can be adjusted adds up to more chord variations. Although these are not all of the possible combinations, the following chart shows the most commonly used forms.

<u>Seventh Types</u>	<u>Formulas</u>	<u>Abbreviations</u>
Major 7th	1 - 3 - 5 - 7	Cmaj7, C ^Δ 7
Minor 7th	1 - b3 - 5 - b7	Cmin7, Cm7, C-7
Dominant 7th	1 - 3 - 5 - b7	C7, C7, G7, D7
Augmented 7th	1 - 3 - #5 - b7	Caug7, C+7
Diminished 7th	1 - b3 - b5 - bb7	Cdim7, C ^o , C ^o 7
Half-Dim. 7th	1 - b3 - b5 - b7	C half-dim, C ^ø 7

Seventh Chord Worksheet

Directions: Fill out the appropriate scale tones in each seventh chord. Remember to adjust them as needed to fulfill the formula for the triad type. Use double sharps or flats as needed.

✓ Check your answers at www.LearnandMasterGuitar.com/answerkey

- | | | | | | | | | | |
|--------------------|-------|-------|-------|-------|-----------------------|-------|-------|-------|-------|
| 1) Gmaj7 | _____ | _____ | _____ | _____ | 11) Bbm7 | _____ | _____ | _____ | _____ |
| 2) Cm7 | _____ | _____ | _____ | _____ | 12) Ebmaj7 | _____ | _____ | _____ | _____ |
| 3) F+7 | _____ | _____ | _____ | _____ | 13) Ab+7 | _____ | _____ | _____ | _____ |
| 4) Bb7 | _____ | _____ | _____ | _____ | 14) C# ^o 7 | _____ | _____ | _____ | _____ |
| 5) Eb ^o | _____ | _____ | _____ | _____ | 15) Gbmaj7 | _____ | _____ | _____ | _____ |
| 6) Abm7 | _____ | _____ | _____ | _____ | 16) Bmin7 | _____ | _____ | _____ | _____ |
| 7) Db7 | _____ | _____ | _____ | _____ | 17) E ^o 7 | _____ | _____ | _____ | _____ |
| 8) F#min7 | _____ | _____ | _____ | _____ | 18) A7 | _____ | _____ | _____ | _____ |
| 9) Bau7 | _____ | _____ | _____ | _____ | 19) Dm7 | _____ | _____ | _____ | _____ |
| 10) E7 | _____ | _____ | _____ | _____ | 20) Gau7 | _____ | _____ | _____ | _____ |

Session 17 Assignment

- Practice Three Note on a String Scales for the full range of the instrument. (page 89)
- Practice the seven scale forms in all twelve keys. Say the notes while playing them.
- Incorporate Hammer-Ons and Pull-Offs as you play the scale forms. Try ascending in one form and descending in the next form. Try playing triplets.
- Play Triplet Scale Practice, Pop Ballad Groove, and ZZ Shuffle with the Jam Along CD. (pages 91-92)

 **Jam Along CD #5**
Track 2 - Slow Version
Track 3 - Medium Version
Track 4 - Fast Version

Triplet Scale Practice

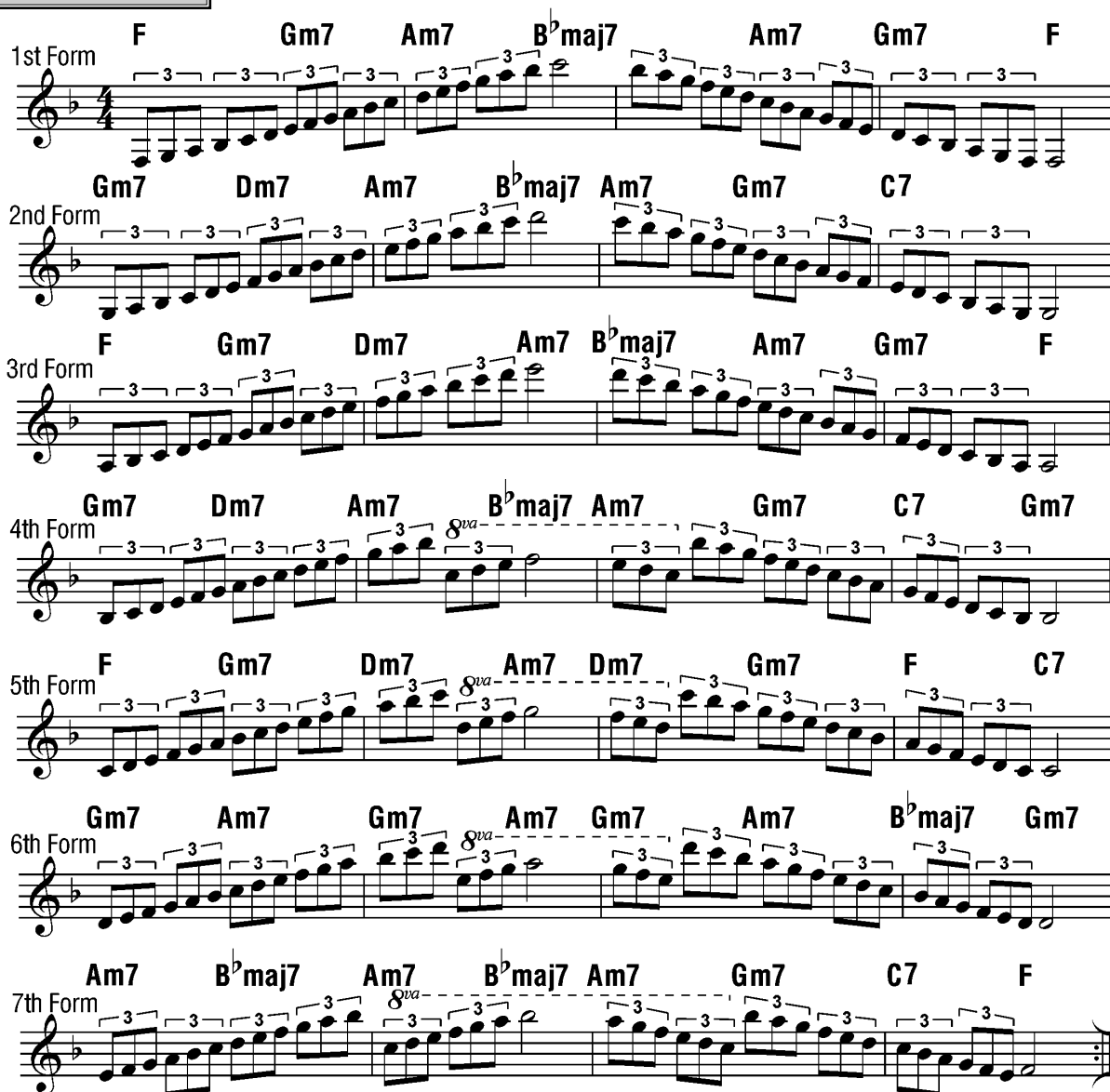

The musical notation consists of seven staves, each representing a different form of a scale. The key signature has one flat (Bb), and the time signature is 4/4. Each staff begins with a treble clef and a key signature of one flat. The notes are grouped into triplets, indicated by a '3' above the notes. Chord symbols are placed above the staves to indicate the harmonic accompaniment for each form. Some notes are marked with '8va' and a dashed line, indicating an octave higher. The forms are as follows:

- 1st Form:** Chords: F, Gm7, Am7, B^bmaj7, Am7, Gm7, F.
- 2nd Form:** Chords: Gm7, Dm7, Am7, B^bmaj7, Am7, Gm7, C7.
- 3rd Form:** Chords: F, Gm7, Dm7, Am7, B^bmaj7, Am7, Gm7, F.
- 4th Form:** Chords: Gm7, Dm7, Am7, B^bmaj7, Am7, Gm7, C7, Gm7.
- 5th Form:** Chords: F, Gm7, Dm7, Am7, Dm7, Gm7, F, C7.
- 6th Form:** Chords: Gm7, Am7, Gm7, Am7, Gm7, Am7, B^bmaj7, Gm7.
- 7th Form:** Chords: Am7, B^bmaj7, Am7, B^bmaj7, Am7, Gm7, C7, F.

Jam Along CD #5
Track 5

Pop Ballad Groove

This song uses a **FIRST** and **SECOND ENDING**. First and Second Endings are a way to repeat a section of music with slightly different endings. The first time through, you play the music, take the first ending and repeat back to the beginning. The second time through, you play the music again, skip over the first ending, take the second ending, and then continue on through the song.

This song also has a **KEY CHANGE** in the fourth line. Notice the key signature difference at the beginning of the fourth line.

Practice strumming the chords then soloing in the key of C using the Three Note on a String Technique.

Slow Ballad

Key Change

Jam Along CD #5
Track 6

ZZ Shuffle

Practice the chords using power chords. Practice soloing in E minor.

Remember that the key of E minor is the same as G major.

Rock Shuffle

SESSION 18 - Jazz



Estimated Time to Learn These Concepts - 3 Weeks

"A jazz musician is a juggler who uses harmonies instead of oranges."

~ Benny Green - Jazz Saxophonist

Chord Melody

A CHORD MELODY involves playing a melody in chords with the melody as the highest tone in the chord and all the other notes voiced beneath the melody note.

C maj7 B maj7 C maj7 Em7 C maj7

Melody Chord Melody

T 5 4 5 3 5 5

A 5 4 5 3 5 5

B 3 2 3 2 3 2

C maj7 B maj7 C maj7 F maj7 F maj7

Melody Chord Melody

T 5 4 5 1 2 2

A 5 4 5 1 2 2

B 3 2 3 2 3 2

Moveable Major Seventh Chords

Fmaj7

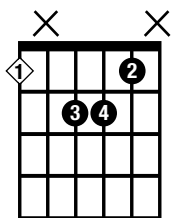

6th String Form

Bmaj7

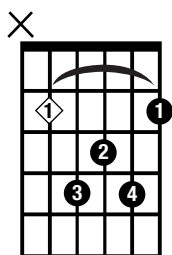

Bmaj7

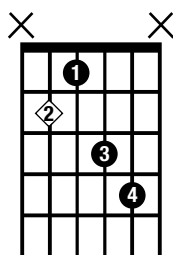

5th String Forms

Dmaj7

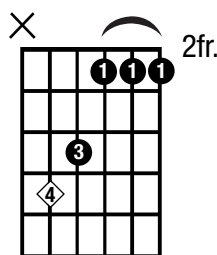

Emaj7

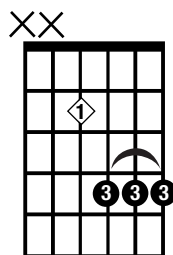

4th String Forms

Gmaj7

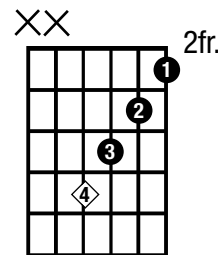

Open Major Seventh Chords

Amaj7

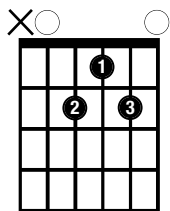

Cmaj7

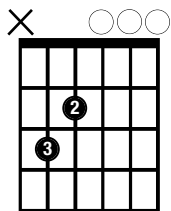

Dmaj7

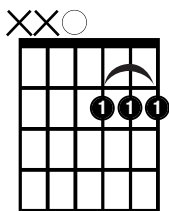

Fmaj7

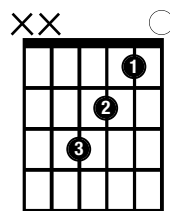

Gmaj7

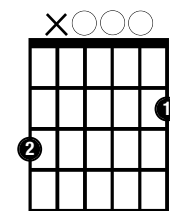

Moveable Minor Seventh Chords

Fm7

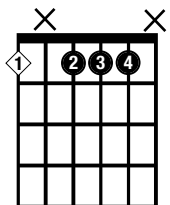

6th String Forms

Fm7

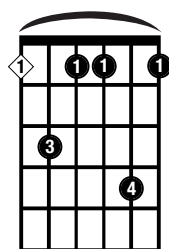

5th String Forms

Cm7

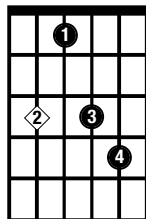

Cm7

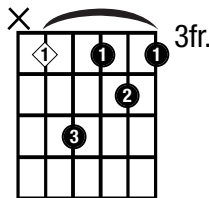

Ninth Chords

A9

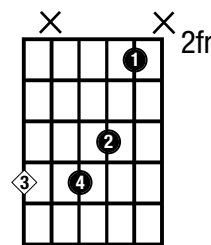

6th String Form

C9

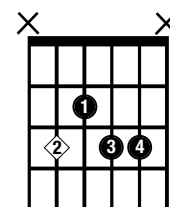

5th String Form

Ways to Jazz up Chord Progressions

Add Color Tones

A COLOR TONE is a tone added to the basic chord to create a more complex chord. Usually these added tones come directly from the major scale, but sometimes they can be major scale tones that have been altered such as a sharpened 9th. Remember that there are only seven notes in a major scale and then they repeat, so if you are referring to a ninth, this is actually the second scale step. The eleventh is the same as the fourth and the thirteenth is the sixth.

Original Chord Progression	C 	Am 	Dm 	G
Adding Color Tones	Cmaj7 	Am11 	Dm9 	G9

Adding the ii-V Progression

Using the harmonized major scale, we learned that the chord built off of the second degree of a major scale is a minor triad. In C, the two (ii) chord would be a D minor. Also, the chord built off of the fifth major scale degree is a major chord. In C, the five chord (V) would be a G major. This combination of a two minor chord to a five major chord is one of the most common chord progressions in jazz. To get to any chord in a jazzy way you can approach it using the two minor and five major in the key of the chord you are going to.

1. Original Chord Progression

Cmaj7 3fr. **Fmaj7**

2. Adding a ii-V to the F

Cmaj7 3fr. **Gm7** 3fr. **C7** 3fr. **Fmaj7**

(the ii and V of F)

3. Adding a ii-V to the F & C

Cmaj7 3fr. **Gm7** 3fr. **C7** 3fr. **Fmaj7** **Dm7** 5fr. **G7** 3fr. **Cmaj7** 3fr.

(the ii and V of F) (the ii and V of C)

Dress up the Dominant Seventh Chord

The fifth chord in the harmonized major scale is called a DOMINANT SEVENTH chord. The dominant seventh chord is abbreviated with the root and a 7 (ie C7, F7 or G7). This chord is almost always preceding the one chord. In C, a G7 goes to a C chord. A dominant seventh chord can be jazzed up by adding color tones to it.

4. Original Chord Progression

Cm7 8fr. **F7** 6fr. **B^bmaj7** 6fr.

5. Adding Color Tones to the F

Cm7 8fr. **F9** 6fr. **B^bmaj7** 6fr.

6. Adding Color Tones to everything

Cm9 **F13** **B^bmaj13** 6fr. **G+7** 3fr. **Cm9**

(the dressed up V of C)

Session 18 Assignment

- Practice the Major Seventh, Minor Seventh, and Ninth Forms. (pages 93-94)
- Practice the Chord Melody example in the book. Try to make up another melody adding chords to it. (page 93)
- Play through the chord progression exercises. (pages 94-95)
- Make up a melody and play it in jazz octaves.
- Play Swingin and Jazz Blues with the Jam Along CD. Practice playing the melody, chordal accompaniment, and soloing over the chord changes. (pages 96-97)

 Jam Along CD #5
Track 7
Track 8 - Without Guitar

Swingin

A standard jazz form consists of playing the melody all the way through one time, then going back through the song soloing over the chord changes, then playing the melody through all the way one last time.

Medium Swing

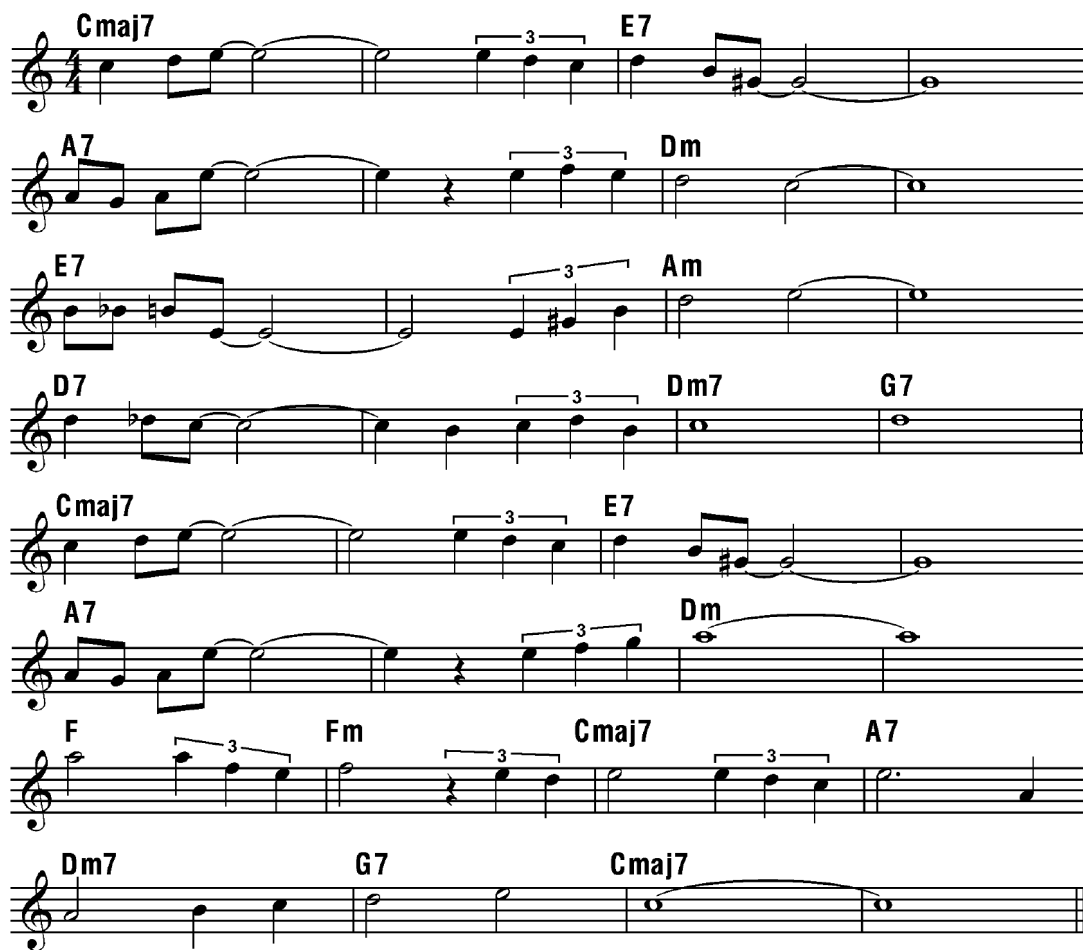

The musical notation for 'Swingin' is written in 4/4 time and consists of eight staves of music. The melody is primarily composed of eighth and quarter notes, with several triplet markings. The chord progression is as follows:

- Staff 1: Cmaj7, E7
- Staff 2: A7, Dm
- Staff 3: E7, Am
- Staff 4: D7, Dm7, G7
- Staff 5: Cmaj7, E7
- Staff 6: A7, Dm
- Staff 7: F, Fm, Cmaj7, A7
- Staff 8: Dm7, G7, Cmaj7

Jam Along CD #5
Track 9

Jazz Blues

♩ = 114 Intro

Medium Swing **F A^b13 G13 G^b13 F**

Chorus 1

F B^b9 F F Cm7 F7 B^b9

F D7 Gm7 C7 F A^b13 G13 G^b13

Chorus 2

F B^b F Cm9 F13 B^b9 B^o

F E E^b D7 Gm9 C13 Am7 D7 Gm7 C7

Chorus 3

Fmaj7 E^o A7 Dm7 C#m7 Cm7 F7/B B^bmaj7 B^bm6

Am7 D7(#9) Gm7 C+ F A^b13 D^b13 G^b13 Fmaj7

Ending

Gm7 C7 F⁶₉

SESSION 19 - Soloing



Estimated Time to Learn These Concepts - 4 Weeks to a Lifetime

"Music is your own experience, your thoughts, your wisdom. If you don't live it, it won't come out of your horn."

~ Charlie Parker - Legendary Jazz Saxophonist

"Don't play what's there, play what's not there."

~ Miles Davis - Jazz Innovator and Trumpeter

"In soloing, there are no wrong notes, just poor choices "

~ Anonymous

Where Do I Start?

1) Look at the key signature.

Determine what key you are in. This will tell you what major scale you could use to begin making a melody from. Then pick and choose notes from the major scale in that key.

2) Let the chord tones guide you.

Ultimately, the chords and the chord tones they represent are the guide for what notes are going to sound right at any particular point in time.

3) Adjust to the style of the song.

Rock soloing incorporates lots of bends and pentatonic scales. Jazz soloing incorporates lots of color tones. Bluegrass soloing uses lots of sequential sixteenth notes. Blues soloing uses pentatonic scales with blues notes.

4) Use finger patterns as a simple starting point.

Once you have the key, you can begin incorporating some of the many finger patterns we have studied in the proper key into your solo (pentatonic scales, scales with blues notes, three note on a string scales, etc.) Be careful, though... Finger patterns alone do not make for a very interesting solo.

5) Creativity involves lots of trial and error.

All of this trial and error improves your ear to better decide which notes work and which notes do not. Be patient with yourself. Everyone sounds bad at first, but slowly you start making better musical choices and more creative melodies.

What makes up a good solo?

1) Melody - You want to create something that is memorable.

2) Balance - All the pieces of the solo need to fit together.

3) Say Something - Avoid just musically mumbling. Find a musical idea and develop it. Take a few notes or a phrase and build something around it.

Chord Tone Soloing Exercises

1. **Cmaj7** **Fmaj7**

2. **C** **Am** **Dm7** **G7**

3. **Jazz** **C** **Am** **Dm7** **G7**
 (repeat measure)

4. **Rock** **C2** **Am9** **Dm9** **G2**

5. **Soft Rock** **Cmaj9** **Am7** **Dm7** **G**

Session 19 Assignment

- Practice soloing on Stevie's Groove with the Jam Along CD. (pages 101)
- Practice Ear Training Exercises 1, 2, & 3 with the Jam Along CD. (pages 100)

Ear Training Exercises

Each example will be played four times. Listen to the phrase in the first measure, then try to play it in the second measure. The first note of each phrase is given. The exercises begin simply then increase in complexity. Look at the chord for hints for the key and the chord tones that may be involved.

Jam Along CD #5
Track 10

1.

Jam Along CD #5
Track 11

2.

Jazz

Jam Along CD #5
Track 12

3.

Rock

Jam Along CD #5
Track 13

Stevie's Groove

Practice playing the chord melody as written and practice soloing over the chord changes. There are two sections to this song. The first section (A) will be repeated four times and then the second section (B) will be repeated twice.

Slow Blues Rock

A

C 8fr. **Csus** 8fr. **C** 8fr. **G** 3fr. **Gsus** 3fr. **G** 3fr. **Am** 5fr. **F**

(repeat 4x)

B

Dm 5fr. **Am** 5fr. **Dm** 5fr. **G** 3fr. **F** **C** 8fr.

SESSION 20 - All The Chords You Need to Know

 Estimated Time to Learn These Concepts - 2 Weeks

"If I don't practice one day, I know it; two days, the critics know it; three days, the public knows it."
 ~ Jascha Heifetz - World Renowned Violinist

Chord Formulas and Abbreviations

The notes to any chord can be found by using the appropriate formulas and the major scale from the key of the chord. The chart below lists the formulas and abbreviations for almost every chord that you will ever see. A chord can be built from the major scale notes and the correct formula. For example: If the chord is "Cm7", the formula is 1-b3-5-b7 and the key is "C". So, when we plug in the right scale tones, the notes for a "Cm7" are C-Eb-G-Bb.

<i>Chord</i>	<i>Formula</i>	<i>Example</i>	<i>Chord</i>	<i>Formula</i>	<i>Example</i>
Triads			9ths		
Major	1-3-5	C	Major 9 th	1-3-5-7-9	CM9, Cmaj9, C ^{Δ9}
Minor	1-b3-5	Cm, C-	Minor 9 th	1-b3-5-b7-9	Cm9, C- ⁹
Augmented	1-3-#5	Caug, C+	Dominant 9 th	1-3-5-b7-9	C9
Diminished	1-b3-b5	Cdim, C	Augmented 9 th	1-3-#5-b7-9	Caug9, C+ ⁹
7ths			11ths		
Major 7 th	1-3-5-7	CM7, Cmaj7, C ^{Δ7}	Minor 11 th	1-b3-5-b7-9-11	Cmin11, Cm11, C- ¹¹
Minor 7 th	1-b3-5-b7	Cm7, C-7	Dominant 11 th	1-3-5-b7-9-11	C11
Dominant 7 th	1-3-5-b7	C7	13ths		
Augmented 7 th	1-3-#5-b7	Caug7, C+7	Major 13 th	1-3-5-7-9-13	Cmaj ¹³ , C ^{Δ13}
Half-Dim. 7 th	1-b3-b5-b7	Chalf-dim7, C ^{ø7}	Minor 13 th	1-b3-5-b7-9-13	Cm13, C- ¹³
Diminished 7 th	1-b3-b5-bb7	Cdim7, C ^{o7}	Dominant 13 th	1-3-5-b7-9-13	C13, C ¹³
Other Chords			Augmented 13 th	1-3-#5-b7-9-13	Caug13, C+ ¹³
Two Chord	1-2-3-5	C2			
Five Chord	1-5	C5			
Suspended	1-4-5	Csus			
Sixth Chord	1-3-5-6	C6			
Minor 6 th	1-b3-5-6	Cm6			
Six-Nine Chord	1-3-5-6-9	C69, C ⁶ ₉			

Altered Chords

ALTERED CHORDS are chords with chord tones that have been adjusted a half step up or down. The note that is to be adjusted is inside a parenthesis. Any alteration only applies to the note that is inside the parenthesis.

- 1. C7(b9)**

Formula:	1	3	5	b7	b9
Chord Tones:	C	E	G	Bb	Db

- 2. F-11(b5,b9)**

Formula:	1	b3	b5	b7	b9	11
Chord Tones:	F	Ab	Cb	Eb	Gb	Bb

Inversions and Alternate Bass Chords

INVERSIONS are chords that use another one of the chord tones instead of the root as the lowest note of the chord. Inversions are notated with a slash. The note underneath the slash is the bass note. For example a G/B would indicate a G chord with the B as the lowest or bass note.

ALTERNATE BASS CHORDS are chords that have a non-chord tone as the lowest or bass note. For example a F/G would indicate an F chord with a G note as the lowest or bass note.

Chords

Inversions

(3rd in Bass)

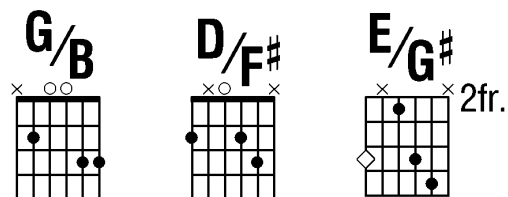

Alternate Bass Chords

(in a key, the IV chord over the V note)

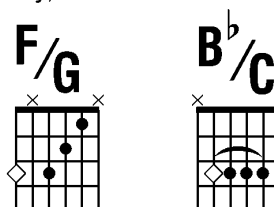

Open E-B Drone Chords

(based on the E5)

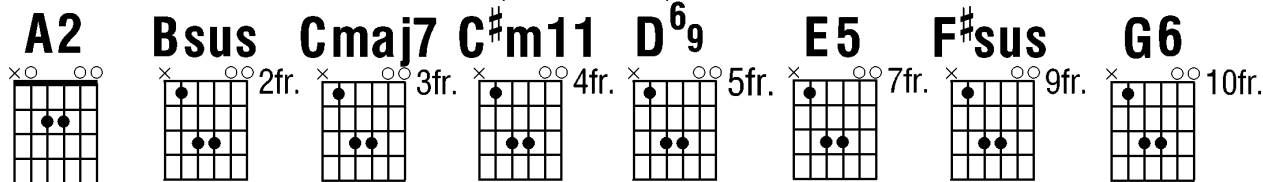

F#m11 based Open Chords

(based on the open F#m11)

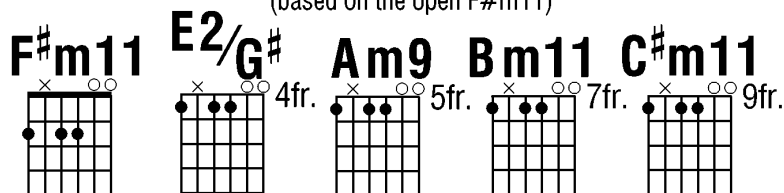

Altered Chords

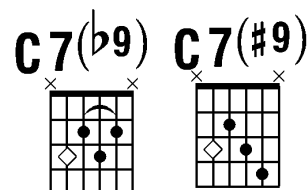

Diminished Chords

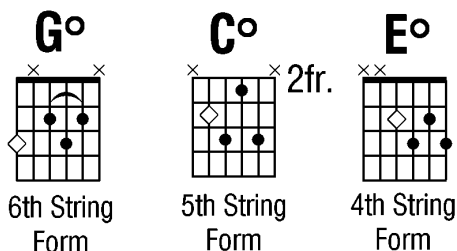

Augmented Chords

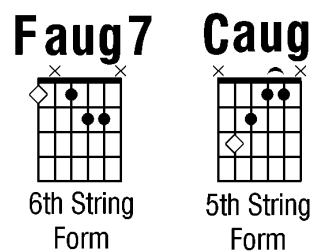

What If I Don't Know A Chord?

If you come across a chord that you don't know, you can ...

- 1) **Build It** - Build your own chord form constructing one from the chord tones used.
- 2) **Look It Up** - Research the chord online or with any all-in-one chord encyclopedia book.
- 3) **Simplify it** - Remove the color tones and break the chord down to the basic triad or seventh elements.

Session 20 Assignment

- Practice Chord Exercises 1 & 2 with the Jam Along CD. (pages 104-105)
- Learn and memorize all of the new chord forms. (page 103)
- Play Friend and Funky Groove with the Jam Along CD. (pages 105)

 Jam Along CD #5
Track 14

Chord Exercise 1

Chord Exercise 1 notation includes the following chords and sequence:

- Staff 1: G, D/F#, Em, Dsus
- Staff 2: C2, G/B, C2, G/B
- Staff 3: C2, G/B, Dsus, D, D/F#, G

(repeat back to beginning)

Jam Along CD #5
Track 15

Chord Exercise 2

Chord diagrams for Cm9, Fm7, G+7 (3fr.), and Cm9 are shown above a musical staff in 4/4 time. The staff contains a sequence of notes and rests corresponding to the chords.

Jam Along CD #5
Track 16

Friend

Strum using the proper chords, then solo in E major.

Up Tempo Acoustic

Section A: Chord diagrams for E5 (7fr.), C#-7 (4fr.), F#m11, E, Esus, and E are shown above a musical staff in 4/4 time.

Section B: Chord diagrams for A2, Bsus, A2, Bsus, F#m11, G#m11 (4fr.), A2, and Bsus are shown above a musical staff in 4/4 time.

Jam Along CD #5
Track 17

Funky Groove

Play rhythm using the chords given, then solo in the key of Eb major. Try to use the correct chord tones for each chord when soloing.

Medium Funk

Section A: Chord diagrams for AbΔ7 (4fr.), Eb/G, F-7 (6fr.), EbΔ7 (6fr.), AbΔ7 (4fr.), Eb/G, F-7 (6fr.), and Ab/Bb (4fr.) are shown above a musical staff in 4/4 time. The staff includes a "Repeat 4x" instruction.

Section B: Chord diagrams for AbΔ7 (4fr.), G+7 (3fr.), C-7 (3fr.), and Db/Eb (6fr.) are shown above a musical staff in 4/4 time. The staff includes a "Repeat 4x" instruction.

Acknowledgments

I am thankful to the Lord for the unexpected opportunity to work on this project. I pray that it will be a blessing to those who learn from it as well as to those of us who have labored to provide it.

I am thankful and grateful to my wonderful wife, Paulette, without whose constant encouragement this project would not exist. Your patience, wisdom, encouragement and support helped me to work harder and produce more than I ever thought possible. I am a blessed man. Also, I am indebted to her for her much needed professional skills of proofreading, editing, and photography. Thanks to my wonderful kids, David, Daniel, and Timothy who knew Daddy as just the man at the computer for months. I pray that the time will be redeemed many times over.

To Gabriel Smith, thank you for the incredible opportunity to work with you on this. May the effort poured into this represent but a fraction of the blessing that it will be to those who learn from it as well as to our own lives and families.

To Jared and Nathan, thank you for your tireless professional efforts during the making of this project.

Thank you to my wonderful parents who faithfully paid for and took me to all those guitar lessons, even though, at times, I begged to quit.

And lastly, an all-too-late thank you to Johnny Frisco, my first and best guitar teacher who died during the completion of this project. I first walked into your lesson room, which was no bigger than a walk-in closet, a six year old with a guitar that was too big for me and came out after many years possessing the musical skills that have shaped my entire life.



CREDITS

Executive Producer:

L. Gabriel Smith

Producer:

Emily Garman

Director:

Paul Williams

Director of Photography:

Paul Williams
Cameron Powell

Cameral Operators:

Bert Elliot
Andy Reuter

Editors:

Paul Williams
Cameron Powell
Bert Elliot
Shelley Boyd
Andy Reuter
Tyler Torti

Script Supervisor:

Adria Haley
Jamie Holmes

Book and Cover Design:

Jared McDaniel, Studio430.com
Spring Sprang, SpringSprang.com

Film Location:

Legacy Learning Studios,
Nashville, TN

Jam Along Band:

Steve Krenz
Abel Orta
Javier Solis
Dino Pastin
Garrett Hestia